

► 2025 FİYAT LİSTESİ



KESİCİ TAKIMLAR KATALOĞU

TEKNOLOJİDE
ÇÖZÜM ORTAĞINIZ





ORMEND MAKİNE

TEKNOLOJİDE ÇÖZÜM ORTAĞINIZ

Ahşap işleme makinaları, kesici takımlar, yedek parça ve teknik servis konularında iş ortaklarımızın daima yanında olmak ve teknolojideki son yenilikleri sizlerle buluşturmak hedefindeyiz.

20 yılı aşkın tecrübemiz, konusunda uzman kadromuzun bilgi ve donanımı ile birlikte siz değerli iş ortaklarımızın ihtiyaçlarına en uygun çözümler üretmek en temel ilkemizdir.

ORMEND ailesi olarak biz, ahşap işleme makinaları ve kesici takım üreten dünyadaki en değerli markaların mümessilliğini yapmanın gururunu yaşamamızın yanında, kendimizi iş ortaklarımıza layık olabilmek adına sürekli geliştirmekteyiz. Ürün satışının dışında, satış sonrasında sizler için ne derece önemli olduğunu bilincindeyiz. Bundan dolayı teknik servis ve yedek parça konularında sizlere en hızlı hizmeti sağlamak için çalışıyoruz.

Saygılarımızla,

ORMEND MACHINE,

YOUR SOLUTION PARTNER IN TECHNOLOGY

We aim to always be with our business partners in wood processing machines, cutting tools, spare parts and technical service and bring you the latest innovations in technology.

Our basic principle is to produce the most suitable solutions for the needs of our valued business partners, with our experience of more than 20 years and the knowledge and equipment of our expert staff.

As the Ormend Family, we are proud to represent the most valuable brands in the world that produce wood processing machines and cutting tools and we are constantly improving to be worthy to our business partners. Apart from product sales, we are aware of how important after sales is for you, so we are working to provide you with the fastest service in technical service and spare parts.

Regards



	STANDART TESTERELER	3
	DİA TESTERELER	13
	PANEL EBATLAMA TESTERELER	15
	MATKAP UÇLARI ve MANDRENLER	19
	KARBÜR ve DİA FREZELER	29
	FREZE BIÇAKLARI	35
	JİLETLİ FREZE TOPLARI	42
	JİLETLER ve PLANYALAR	45
	POLİÜRETAN HORTUMLAR	46

STANDART TESTERELER

CMT ORANGE
TOOLS®



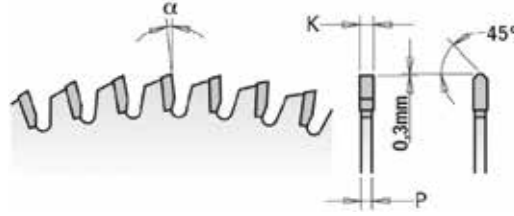

MDF & SUNTALAM TESTERELER

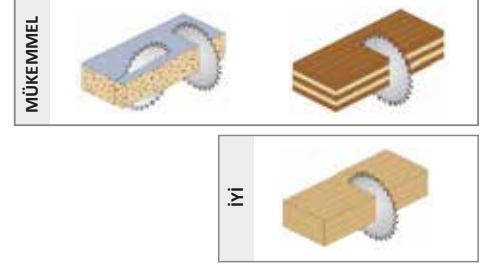

Order No.	D	K	P	d	Z	FT	α	β	Fiyat
281.160.40H	160	2.2	1.6	20	40	4/7/32	10°	TCG	57,50 €
281.064.08M	200	3.2	2.2	30	64	2/7/42	10°	TCG	65,00 €
281.064.09M	220	3.2	2.2	30	64	2/7/42	10°	TCG	61,00 €
281.080.10M	250	3.2	2.2	30	80	2/10/60	10°	TCG	70,50 €
281.072.12M	300	3.2	2.2	30	72	2/10/60	10°	TCG	74,00 €
281.096.12M	300	3.2	2.2	30	96	2/10/60	10°	TCG	82,00 €
281.084.14M	350	3.5	2.5	30	84	2/10/60	10°	TCG	98,00 €
281.108.14M	350	3.5	2.5	30	108	2/10/60	10°	TCG	112,50 €



CHROME MDF & SUNTALAM TESTERELER



Order No.	D	K	P	d	Z	FT	α	β	Fiyat
281.680.10M	250	3.2	2.2	30	80	2/10/60	5°	TCG	94,00 €
281.672.12M	300	3.2	2.2	30	72	2/10/60	10°	TCG	93,00 €
281.696.12M	300	3.2	2.2	30	96	2/10/60	5°	TCG	99,00 €
281.708.14M	350	3.5	2.5	30	108	2/10/60	5°	TCG	143,00 €

TEKLİ ÇİZİCİ TESTERELER

ÇİFTLİ ÇİZİCİ TESTERELER

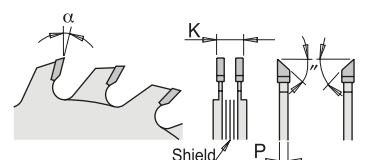
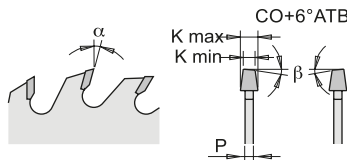

Order No.	D	K	FT	d	Z		α	β	Fiyat
288.125.24H	125	3.1-4.0		20	24	Tekli	5°	CO+5° ATB	53,00 €
288.725.24H	125	3.1-4.3		20	24	Tekli Chrome	0°	CO+6° ATB	55,00 €
288.125.24K	125	3.1-4.0		22	24	Tekli	5°	CO+5° ATB	55,00 €
289.725.24H	125	2.8-3.6	2/4.2/42	20	12+12	Çiftli Chrome	11°	5° ATB	92,50 €

*Fiyatlarımıza KDV Dahil Değildir.

*Diğer ölçüler için lütfen iletişime geçin.



ÇOKLU DİLME TESTERELER

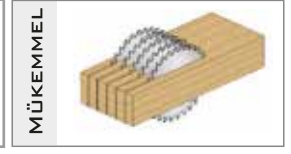
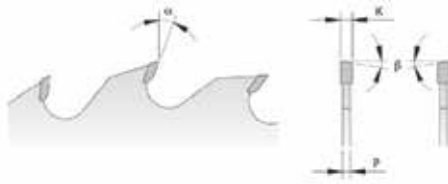

Order No.	D	K	P	T ₁ mm	d	Z	KAMA - PİN	α	β	Fiyat
280.021.08S	200	2.5	1.8	35	40	21+3		18°	FLAT	70,00 €
279.020.10M	250	3.2	2.2	65	30*	20+4	COMBI 3	18°	10° ATB	70,00 €
280.020.10V	250	2.7	1.8	50	70	20+4	21x8	18°	10° ATB	70,00 €
279.024.12M	300	3.2	2.2	80	30*	24+4	COMBI 3	18°	10° ATB	80,00 €
279.024.12V	300	3.2	2.2	80	70	24+4	21x8	18°	10° ATB	80,00 €
279.028.14M	350	3.5	2.5	105	30*	28+4	COMBI 3	18°	10° ATB	100,00 €
279.028.14V	350	3.5	2.5	105	70	28+4	21x6	18°	10° ATB	100,00 €
279.028.16M	400	4.0	2.8	120	30*	28+6	COMBI 3	18°	10° ATB	150,00 €

* İstenilen ölçülere göre göbek ve kama deliği ayarlanabilir.

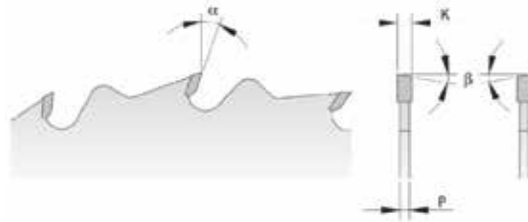

AHŞAP KESİM TESTERELER (Atlamalı Diş)

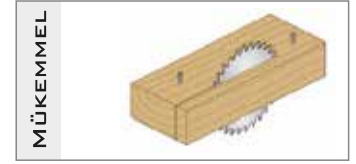

Order No.	D	K	P	d	Z	FT	α	β	Fiyat
290.250.24M	250	2.8	1.8	30	24	2/10/60	20°	10° ATB	32,50 €
278.028.12M	300	3.2	2.2	30	28	2/10/60	18°	10° ATB	50,00 €
286.020.12M	300	2.8	1.8	30	20	2/10/60	15°	5° ATB	39,00 €
278.036.14M	350	3.5	2.5	30	36	2/10/60	18°	10° ATB	63,00 €
285.036.16M	400	3.5	2.5	30	36	2/10/60	20°	10° ATB	68,00 €
285.036.18M	450	3.8	2.8	30	36	2/10/60	20°	10° ATB	74,50 €
285.044.20M	500	4.0	2.8	30	44	2/10/60	20°	10° ATB	109,00 €
286.040.22M	550	4.2	3.2	30	40	2/10/60	15°	5° ATB	109,00 €
286.040.24M	600	4.2	3.2	30	40	2/10/60	15°	5° ATB	118,00 €
286.046.28M	700	4.4	3.2	30	46	2/10/60	15°	5° ATB	163,00 €

ULTRA HASSAS KESİM TESTERE (SAĞ-SOL)

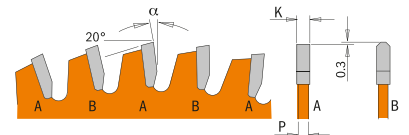
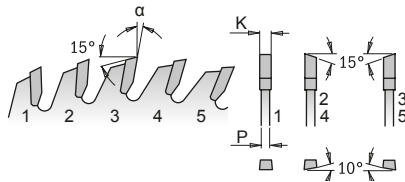

Order No.	D	K	P	d	Z	FT	α	β	Fiyat
274.100.12M XTREME	300	3.2	2.2	30	100	2/10/60	15°	1FTG+4ATB	96,00 €
276.300.96M (DECK)	300	2.8	2.0	30	96	2/10/60	-6°NEG.	TCG	80,00 €

*Fiyatlarımıza KDV Dahil Değildir.

*Diğer ölçüler için lütfen iletişime geçin.



AHŞAP ve KAPLAMALI MALZEME KESİM TESTERELER (Sık Diş)

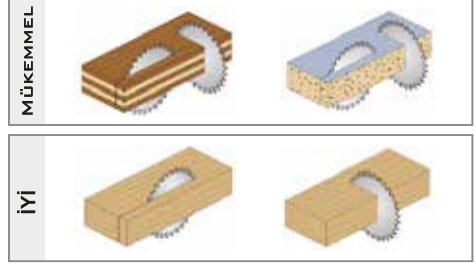
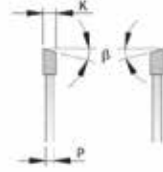

Order No.	D	K	P	d	Z	FT	α	β	Fiyat
285.056.07M	180	3.2	2.2	30	56	2/7/42	5°	15° ATB	55,00 €
285.048.08M	200	3.2	2.2	30	48	2/10/60 + 2/7/42	15°	15° ATB	52,00 €
285.048.10M	250	3.2	2.2	30	48	2/10/60	15°	10° ATB	53,00 €
285.060.10M	250	3.2	2.2	30	60	2/10/60	10°	15° ATB	55,00 €
285.080.10M	250	3.2	2.2	30	80	2/10/60	5°	15° ATB	75,00 €
285.060.11M	260	2.8	1.8	30	60	2/10/60 + 2/7/42	10°	15° ATB	60,50 €
295.064.11M	280	2.8	1.8	30	64	2/10/60 + 2/7/42	10°	15° ATB	77,00 €
285.048.12M	300	3.2	2.2	30	48	2/10/60	15°	10° ATB	59,50 €
285.060.12M	300	3.2	2.2	30	60	2/10/60	15°	10° ATB	66,00 €
285.072.12M	300	3.2	2.2	30	72	2/10/60	10°	15° ATB	74,00 €
285.096.12M	300	3.2	2.2	30	96	2/10/60	5°	15° ATB	88,00 €
285.072.22M	305	3.2	2.2	30	72	2/10/60	10°	15° ATB	82,50 €
285.0.72.13M	315	3.2	2.2	30	72	2/10/60	15°	10° ATB	82,50 €
285.054.14M	350	3.5	2.5	30	54	2/10/60	15°	10° ATB	76,00 €
285.072.14M	350	3.5	2.5	30	72	2/10/60	15°	10° ATB	82,00 €
285.084.14M	350	3.5	2.5	30	84	2/10/60	10°	15° ATB	97,00 €
285.048.16M	400	3.5	2.5	30	48	2/10/60	20°	10° ATB	89,00 €
285.060.16M	400	3.5	2.5	30	60	2/10/60	10°	15° ATB	102,50 €
285.054.18M	450	3.8	2.8	30	54	2/10/60	15°	15° ATB	117,00 €
285.066.18M	450	3.8	2.8	30	66	2/10/60	10°	15° ATB	141,00 €
285.060.20M	500	3.8	2.8	30	60	2/10/60	15°	15° ATB	139,00 €
285.072.20M	500	3.8	2.8	30	72	2/10/60	10°	15° ATB	166,00 €
285.060.22M	550	4.2	3.2	30	60	2/10/60	10°	15° ATB	159,50 €
285.066.24M	600	4.2	3.2	30	66	2/10/60	10°	15° ATB	166,00 €
285.072.28M	700	4.4	3.2	30	72	2/10/60	10°	15° ATB	219,00 €

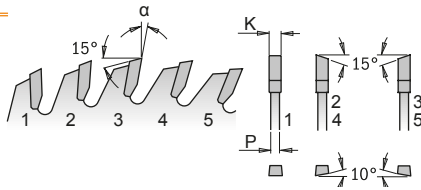

ULTRA İNCE TESTERELER (AHŞAP KESİM)

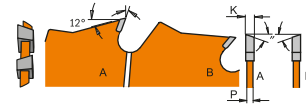

Order No.	D	K	P	d	Z	FT	α	β	Fiyat
273.300.96M	300	2.6	1.8	30	96	2/10/60	12°	10° ATB+8°	84,00 €
273.250.80M	250	2.4	1.6	30	80	2/10/60	12°	10° ATB+8°	58,50 €
271.300.48M	300	2.6	1.8	30	48	2/10/60	18°	10° ATB+8°	60,50 €
271.300.24M BG	300	2.6	1.8	30	24	2/10/60	22°	10° ATB+8°	49,50 €
271.250.42M	250	2.4	1.6	30	42	2/10/60	18°	10° ATB+8°	46,50 €
271.250.24M BG	250	2.4	1.6	30	24	2/10/60	20°	10° ATB+8°	35,50 €
S 272.04180	250	2.2	1.6	30	40	2/10/60	20°	1FTG+4ATB	54,00 €

*Fiyatlarımıza KDV Dahil Değildir.

*Diğer ölçüler için lütfen iletişime geçin.



CHROME KURT DİŞ MDFLAM TESTERELER

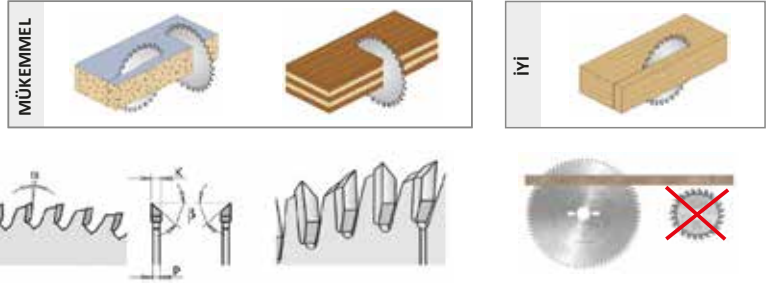

Order No.	D	K	P	d	Z	FT	α	β	Fiyat
283.680.10M	250	3.2	2.2	30	80	2/10/60	-2° Neg.	38° ATB	95,00 €
283.696.12M	300	3.2	2.2	30	96	2/10/60	2°	38° ATB	115,50 €

KURT DİŞ MDFLAM TESTERELER

Order No.	D	K	P	d	Z	FT	α	β	Fiyat
283.080.10M	250	3.2	2.2	30	80	2/10/60	-2° Neg.	40° ATB	82,00 €
283.096.12M	300	3.2	2.2	30	96	2/10/60	2°	40° ATB	99,00 €
283.108.14M	350	3.5	2.5	30	108	2/10/60	5°	40° ATB	120,00 €

CHROME AHŞAP ve KAPLAMALI MALZEME KESİM TESTERELER (Sık Diş)

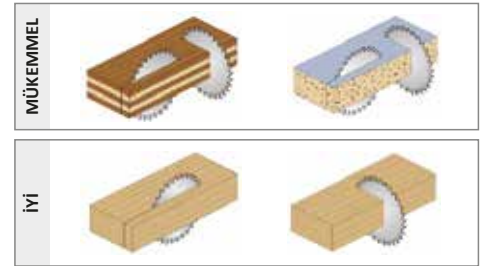
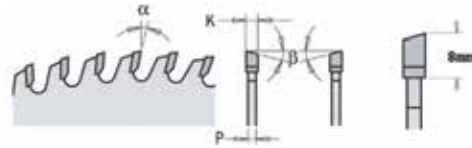

Order No.	D	K	P	d	Z	FT	α	β	Fiyat
285.640.10M	250	3.2	2.2	30	40	2/10/60	15°	10° ATB	57,50 €
285.660.10M	250	3.2	2.2	30	60	2/10/60	10°	15° ATB	69,00 €
285.680.10M	250	3.2	2.2	30	80	2/10/60	5°	15° ATB	91,50 €
285.648.12M	300	3.2	2.2	30	48	2/10/60	15°	10° ATB	80,50 €
285.672.12M	300	3.2	2.2	30	72	2/10/60	10°	15° ATB	89,00 €
285.696.12M	300	3.2	2.2	30	96	2/10/60	5°	15° ATB	110,00 €
285.654.14M	350	3.5	2.5	30	54	2/10/60	15°	10° ATB	98,00 €
285.684.14M	350	3.5	2.5	30	84	2/10/60	10°	15° ATB	118,00 €
285.708.14M	350	3.5	2.5	30	108	2/10/60	5°	15° ATB	135,50 €

*Diğer ölçüler için lütfen iletişime geçin.

*Fiyatlarımıza KDV Dahil Değildir.



CHROME OLUKLU DİŞ HASSAS KESİM TESTERELER

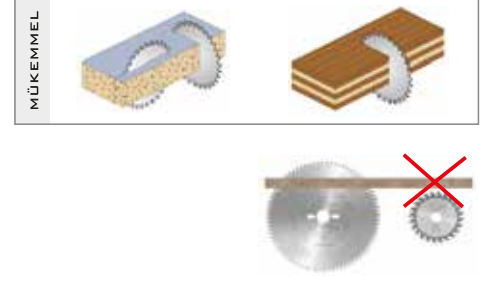
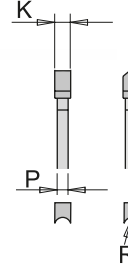

Order No.	D	K	P	d	Z	FT	α	β	Fiyat
287.648.10M	250	3.2	2.2	30	48	2/10/60	10°	HDF	99,00 €
287.660.12M	303	3.2	2.2	30	60	2/10/60	10°	HDF	121,00 €

OLUKLU DİŞ HASSAS KESİM TESTERELER

Order No.	D	K	P	d	Z	FT	α	β	Fiyat
287.048.10M	250	3.2	2.2	30	48	2/10/60	10°	HDF	86,00 €
287.060.12M	303	3.2	2.2	30	60	2/10/60	10°	HDF	108,00 €

PORTATİF MAKİNA TESTERELER

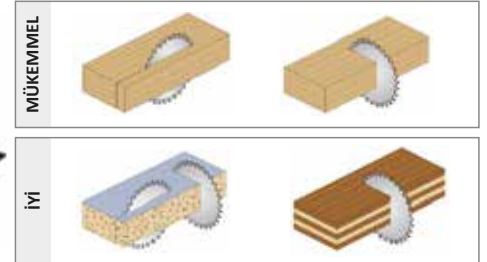

Order No.	D	K	P	d	Z	FT	α	β	Fiyat
291.160.24M	160	2.2	1.6	30	24	2/7/42	15°	15° ATB	29,00 €
292.160.40H	160	2.2	1.6	20	40	2/6/32	10°	15° ATB	36,50 €
292.160.40M	160	2.2	1.6	30	40	2/7/42	10°	15° ATB	36,50 €
285.160.48H	160	2.2	1.6	20	48	2/6/32	5°	15° ATB	41,00 €
291.180.24H	180	2.6	1.6	20	24	2/6/32	20°	10° ATB	31,00 €
291.180.24M	180	2.6	1.6	30	24	2/7/42	20°	10° ATB	31,00 €
292.180.40H	180	2.6	1.6	20	40	2/6/32	15°	15° ATB	40,00 €
292.180.40M	180	2.6	1.6	30	40	2/7/42	15°	15° ATB	40,00 €
291.190.24H	190	2.6	1.6	20	24	2/6/32	20°	10° ATB	32,00 €
291.190.24M	190	2.6	1.6	30	24	2/7/42	20°	10° ATB	32,00 €
292.190.40M	190	2.6	1.6	30	40	2/7/42	15°	15° ATB	40,00 €
292.190.48FF	190	2.4	1.8	20-16	48	5/7/2,5	10°	15° ATB	45,00 €
291.200.36M	200	2.8	1.8	30	36	2/7/42	15°	15° ATB	43,00 €
292.200.48M	200	2.8	1.8	30	48	2/7/42	15°	15° ATB	45,00 €
292.210.64M	210	2.8	1.8	30	64	2/7/42	15°	15° ATB	59,50 €

*Fiyatlarımıza KDV Dahil Değildir.

*Diğer ölçüler için lütfen iletişime geçin.

CORIAN ve DOLU MALZEME KESİM TESTERELER

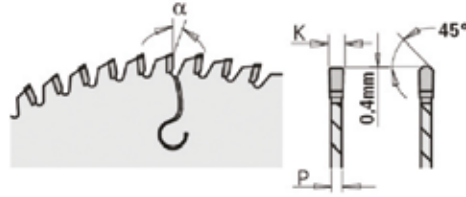

Order No.	D	K	P	d	Z	FT	α	β	Fiyat
223.072.10M	250	3.2	2.5	30	72		0°	MTCG	81,50 €
223.084.12M	300	3.2	2.5	30	84		0°	MTCG	90,50 €

PVC & PLEXIGLASS TESTERELER

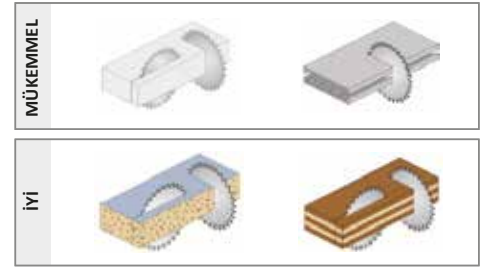
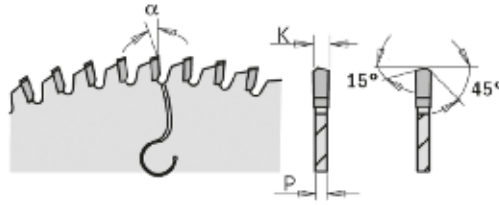

Order No.	D	K	P	d	Z	FT	α	β	Fiyat
222.080.10M	250	2.8	2.2	30	80	2/10/60	-3°Neg.	MATB	86,00 €
222.096.12M	300	2.8	2.2	30	96	2/10/60	-3°Neg.	MATB	104,50 €

ÇİM BİÇME TESTERELER

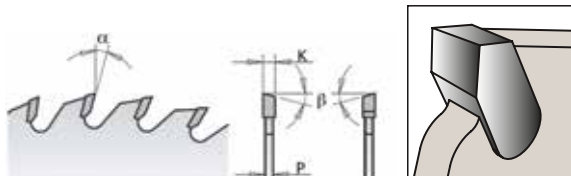

Order No.	D	K	P	d	Z	RPM _{max.}	α	β	Fiyat
298.250.20	250	2.2	1.4	25.4	20	12.000	15°	10° ATB	30,00 €

*Diğer ölçüler için lütfen iletişime geçin.

*Fiyatlarımıza KDV Dahil Değildir.



(DRY CUT) METAL PROFİL KESİM TESTERELER

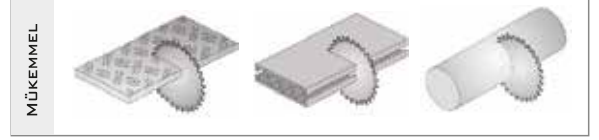

Order No.	D	K	P	d	Z	RPM	FT	α	β	Fiyat
226.032.06H	150	1.6	1.2	20	32	4400		0°	8° FWF	46,50 €
226.036.06	165	1.6	1.2	15.87	36	4000		0°	8° FWF	51,00 €
226.048.07	184	2.0	1.6	15.87	48	3600		0°	8° FWF	67,00 €
226.040.07M	190	2.0	1.6	30	40	3500	2/7/42	0°	8° FWF	60,50 €
226.048.08M	210	2.2	1.8	30	48	3100	2/7/42	0°	8° FWF	68,50 €
226.048.09M	235	2.2	1.8	30	48	3000	2/7/42	0°	8° FWF	74,00 €
226.060.10	254	2.2	1.8	15.87	60	2600		0°	8° FWF	110,00 €
226.060.10M	254	2.2	1.8	30	60	2600	COMBI3	0°	8° FWF	110,00 €
226.060.12	305	2.2	1.8	25.4	60	2100		0°	8° FWF	117,00 €
226.080.12	305	2.2	1.8	25.4	80	2100		0°	8° FWF	146,50 €
226.080.12M	305	2.2	1.8	30	80	2100	COMBI3	0°	8° FWF	146,50 €
226.072.14	355	2.2	1.8	25.4	72	1800		0°	8° FWF	126,50 €
226.090.14	355	2.2	1.8	25.4	90	1800		0°	8° FWF	159,50 €
226.090.14M	355	2.2	1.8	30	90	1800	COMBI3	0°	8° FWF	159,50 €

(DRY CUT) PASLANMAZ ÇELİK PROFİL KESİM TESTERELER

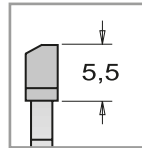

Stainless Steel

SPECIAL CARBIDE
CERMET

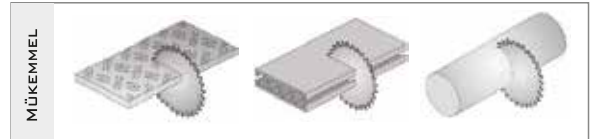

Order No.	D	K	P	d	Z	RPM	FT	α	β	Fiyat
226.580.12	305	2.2	1.8	25.4	80	2100		0°	8° FWF	170,50 €
226.580.12M	300	2.2	1.8	30	80	2200	COMBI3	0°	8° FWF	170,50 €
226.590.14	355	2.2	1.8	25.4	90	1800		0°	8° FWF	187,00 €
226.590.14M	355	2.2	1.8	30	90	1800	COMBI3	0°	8° FWF	187,00 €

*Fiyatlarımıza KDV Dahil Değildir.

*Diğer ölçüler için lütfen iletişime geçin.



ALÜMİNYUM TESTERELER

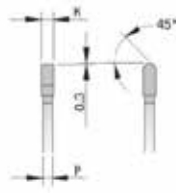
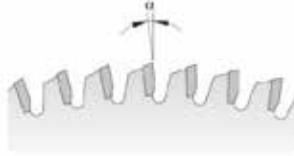

Order No.	D	K	P	d	Z	FT	α	FİYAT
297.080.10M	250	3,2	2,5	30	80	COMBI 3	-6° Neg.	77,00 €
297.080.10P	250	3,2	2,5	32	80	2/12/64	-6° Neg.	77,00 €
297.096.12M	300	3,2	2,5	30	96	COMBI 3	-6° Neg.	87,00 €
297.096.12P	300	3,2	2,5	32	96	2/12/64	-6° Neg.	87,00 €
297.108.14M	350	3,6	3,0	30	108	COMBI 3	-6° Neg.	104,50 €
297.108.14P	350	3,6	3,0	32	108	4/12/64	-6° Neg.	104,50 €
297.108.16P	400	4,0	3,2	32	96	4/12/64	-6° Neg.	147,50 €
297.120.16M	400	4,0	3,2	30	120	2/10/60	-6° Neg.	170,50 €
297.120.16P	400	4,0	3,2	32	120	4/12/64	-6° Neg.	170,50 €
297.108.18M	450	4,2	3,5	30	96	2/10/60	-6° Neg.	176,00 €
297.108.18P	450	4,2	3,5	32	96	2/12/64	-6° Neg.	176,00 €
297.120.18P	450	4,2	3,5	32	120	4/12/64	-6° Neg.	181,50 €
297.120.20M	500	4,3	3,5	30	120	2/10/60	-6° Neg.	187,00 €
297.120.20P	500	4,3	3,5	32	120	2/12/64	-6° Neg.	187,00 €

KANAL TESTERELER

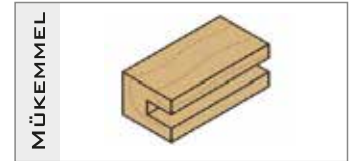
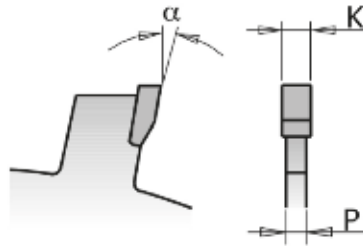

Order No.	D	K	P	d	Z	FT	α	β	Fiyat
240.040.06M	150	4.0	3.0	30	12		15°	FLAT	42,00 €
240.050.06M	150	5.0	3.0	30	12		15°	FLAT	48,50 €
240.060.06M	150	6.0	3.0	30	12		15°	FLAT	49,50 €
240.040.07M	180	4.0	3.0	30	18		15°	FLAT	52,00 €
240.050.07M	180	5.0	3.0	30	18		15°	FLAT	55,00 €
240.060.07M	180	6.0	3.0	30	18		15°	FLAT	59,50 €
S 240.04008	200	4.0	3.0	30	18		15°	FLAT	49,50 €
S 240.05008	200	5.0	3.0	30	18		15°	FLAT	55,00 €
S 240.06008	200	6.0	3.0	30	18		15°	FLAT	60,50 €
S 240.07008	200	7.0	5.0	30	18		15°	FLAT	66,00 €
S 240.08008	200	8.0	5.0	30	18		15°	FLAT	71,50 €

*İstenilen ölçü üretim yapılmaktadır.

*Fiyatlarımıza KDV Dahil Değildir.

*Diğer ölçüler için lütfen iletişime geçin.



230.312.08M

DADO KANAL TESTERESİ (6-20 mm Arası Ayarlı)

Kanal Geniřlięi		6mm	7mm	8mm	9mm	10mm	11mm	12mm	13mm	14mm	15mm	16mm	17mm	18mm	19mm	20mm
A	Sol Bıçak (203 mm 1 Ad.)	•	•	•	•	•	•	•	•	•	•	•	•	•	•	•
B	Saę Bıçak (203 mm 1 Ad.)	•	•	•	•	•	•	•	•	•	•	•	•	•	•	•
C	Ara Bıçak (3.14 mm 3 Ad.)	0	0	0	0	1	1	1	2	2	2	2	3	3	3	3
D	Kilit Ara Parça Pvc (1.6 mm 3 Ad.)	0	0	1	1	0	1	1	0	1	1	2	0	1	2	2
E	PVC Pul (0.1 mm 5 Ad.)	0	0	0	2	1	0	0	0	1	1	0	4	0	0	2
F	PVC Pul (0.2 mm 2 Ad.)	0	1	2	2	1	1	2	1	0	1	1	2	1	2	2
G	Manyetik Pul (0.3 mm 1 Ad.)	0	1	0	1	0	0	1	0	0	1	1	1	1	0	1
H	Manyetik Pul (0.5 mm 1 Ad.)	0	1	0	1	1	0	1	1	0	1	0	1	1	0	1

Order No.	D	K	P	d	Z	FT	α	β	Fiyat
230.312.08M	203	6-20		30	12-12		-12*	FTG + ATB	242,00 €

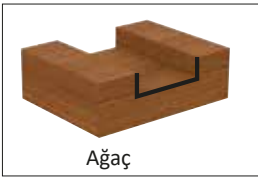
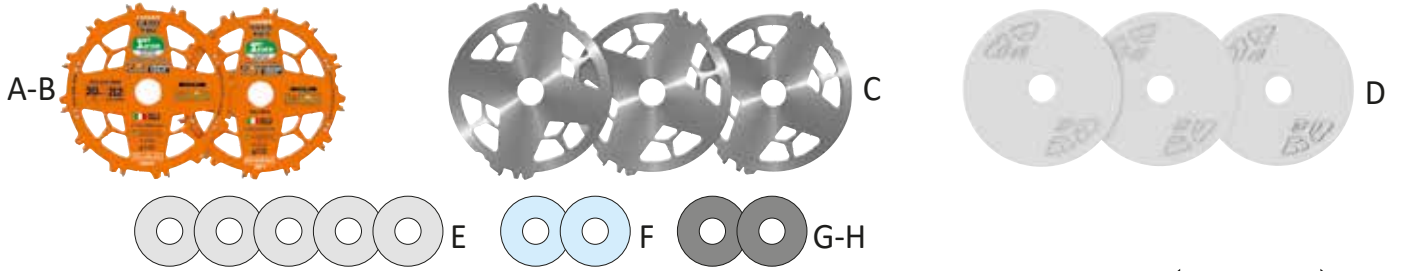

Ağaç

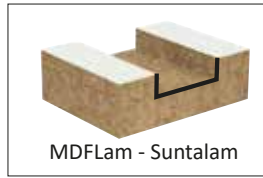

MDFLam - Suntalam

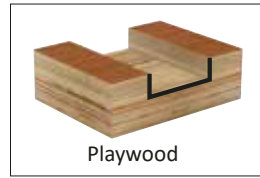

Playwood

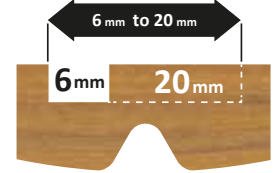

*Fiyatlarımıza KDV Dahil Deęildir. *Dięer ölçüler için lütfen iletişime geçin.



20X
UZUN ÖMÜR



DİA OLUKLU TESTERE (ÇİZİCSİZ)

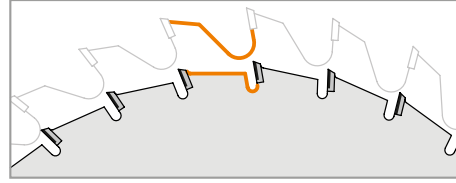
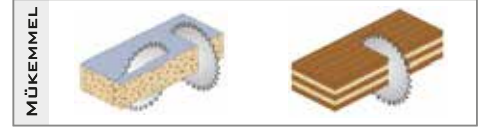
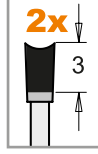
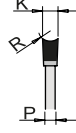

Order No.	D	K	P	d	Z	FT	α	β	Fiyat
235.250.36M	250	2.5	2.0	30	36	COMBI3	10°	HR	577,50 €
235.300.44M	300	2.5	2.0	30	44	COMBI3	10°	HR	660,00 €



50X
UZUN ÖMÜR



DİA MDF & SUNTALAM TESTERE

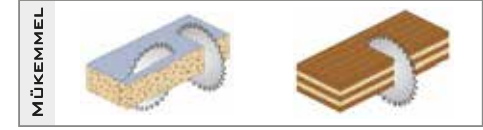
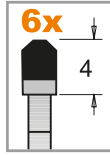

Order No.	D	K	P	d	Z	FT	α	β	Fiyat
237.048.10M	250	3.2	2.2	30	48	COMBI3	10°	45° TCG	1.020,00 €
237.060.12M	300	3.2	2.2	30	60	COMBI3	10°	45° TCG	1.238,00 €
237.072.14M	350	3.5	2.4	30	72	COMBI3	15°	45° TCG	1.509,00 €

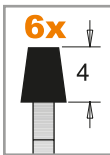

50X
UZUN ÖMÜR



DİA ÇİZİCİ TESTERE

Order No.	D	K	P	d	Z	FT	α	β	Fiyat
238.120.20H	120	3.1-3.7		20	20		5°	CON	528,00 €
238.125.20H	125	3.1-3.7		20	20		5°	CON	528,00 €

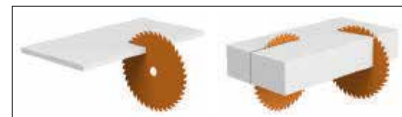
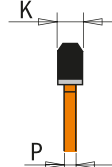
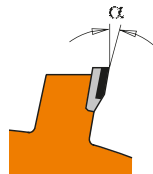

DİA ULTRA TESTERE (BETOPAN/ETERNIT/ CORIAN/FORMICA)

Order No.	D	K	P	d	Z	FT	α	β	Fiyat
236.250.16M	250	2.4	1.8	30	16	COMBI3	12°	TCG	231,00 €

*Fiyatlarımıza KDV Dahil Değildir.

*Diğer ölçüler için lütfen iletişime geçin.

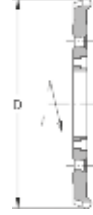
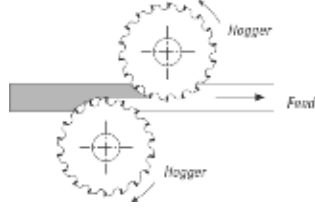

COMPACT DİA HOGGER

Order No.	D	K	P	d	Z	FT	RH/LH	Fiyat
003901L	250	10		80	24		LH	Fiyat bilgisi için irtibata geçiniz.
003901R	250	10		80	24		RH	Fiyat bilgisi için irtibata geçiniz.
003902L	250	10		80	36		LH	Fiyat bilgisi için irtibata geçiniz.
003902R	250	10		80	36		RH	Fiyat bilgisi için irtibata geçiniz.
003903L	250	10		80	48		LH	Fiyat bilgisi için irtibata geçiniz.
003903R	250	10		80	48		RH	Fiyat bilgisi için irtibata geçiniz.

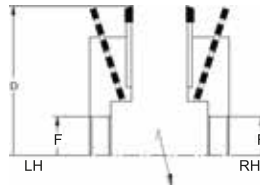
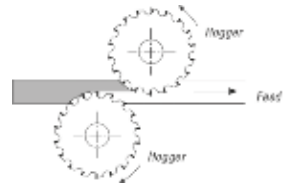

DİA HOGGER

Order No.	D	K	P	d	Z	FT	RH/LH	Fiyat
0033.251.31	250	18		35 DKN	48F+6x4		LH	Fiyat bilgisi için irtibata geçiniz.
0033.251.01	250	18		35 DKN	48F+6x4		RH	Fiyat bilgisi için irtibata geçiniz.
0033.251.41	250	18		35 DKN	72F+6x4		LH	Fiyat bilgisi için irtibata geçiniz.
0033.251.10	250	18		35 DKN	72F+6x4		RH	Fiyat bilgisi için irtibata geçiniz.

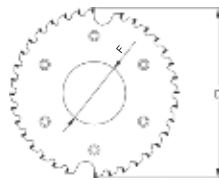

SEGMENT DİA HOGGER

Order No.	D	K	P	d	Z	FT	RH/LH	Fiyat
0032.250.08	250	4.0	2.8	80	48F	6/10/200	LH	Fiyat bilgisi için irtibata geçiniz.
0032.250.09	250	4.0	2.8	80	48F	6/10/200	RH	Fiyat bilgisi için irtibata geçiniz.
0032.250.80	250	4.0	2.8	80	72F	6/10/200	LH	Fiyat bilgisi için irtibata geçiniz.
0032.251.80	250	4.0	2.8	80	72F	6/10/200	RH	Fiyat bilgisi için irtibata geçiniz.
0032.255.41	250	4.0	2.8	100	54F	6/10/200	LH	Fiyat bilgisi için irtibata geçiniz.
0032.256.41	250	4.0	2.8	100	54F	6/10/200	RH	Fiyat bilgisi için irtibata geçiniz.
0032.257.41	250	4.0	2.8	80	60F	6/10/200	LH	Fiyat bilgisi için irtibata geçiniz.
0032.258.41	250	4.0	2.8	80	60F	6/10/200	RH	Fiyat bilgisi için irtibata geçiniz.

*Fiyatlarımıza KDV Dahil Değildir.

*Diğer ölçüler için lütfen iletişime geçin.

PANEL EBATLAMA TESTERELER

CMT ORANGE
TOOLS®





PANEL EBATLAMA ANA TESTERELER

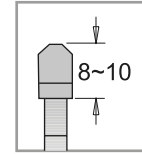
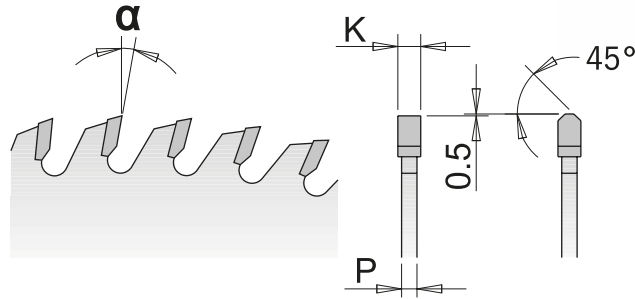

Order No.	D	K	P	d	Z	PiN	α	β	Fiyat
282.060.12M	300	4.4	3.2	30	60	COMBI3	16°	TCG	148,50 €
282.072.13J	320	4.4	3.2	65/75	72	(2/9/100+2/9/110) 3/7/100	16°	TCG	159,50 €
282.072.14M	350	4.4	3.2	30	72	COMBI3	16°	TCG	170,50 €
282.072.14T	350	4.4	3.2	50	72	3/13/80	16°	TCG	170,50 €
282.072.14J2	355	4.4	3.2	65	72	2/9/100 + 2/9/110	16°	TCG	176,00 €
282.072.14W2	355	4.4	3.2	80	72	4/9/100 + 2/9/110 + 2/14/110	16°	TCG	176,00 €
282.072.15U2	380	4.4	3.2	60	72	2/14/100	16°	TCG	198,00 €
282.072.15W	380	4.4	3.2	80	72	COMBI5	16°	TCG	198,00 €
282.072.16M	400	4.4	3.2	30	72	2/10/60	16°	TCG	198,00 €
282.072.16X	400	4.4	3.2	72	72	4/15/105	16°	TCG	198,00 €
282.072.16W	400	4.4	3.2	80	72	COMBI5	16°	TCG	198,00 €
Y282.072.17J	430	4.4	3.2	65	72	2/9/100 + 2/9/110	16°	TCG	220,00 €
282.072.17X	430	4.4	3.2	75	72	4/15/105	16°	TCG	220,00 €
282.072.17W2	430	4.4	3.2	80	72	COMBI5	16°	TCG	220,00 €
Y282.072.18M2	450	4.4	3.2	30	72	2/10/60+2/13/94	16°	TCG	247,50 €
282.072.15U	380	4.8	3.5	60	72	2/14/100	16°	TCG	220,00 €
282.072.18U	450	4.8	3.5	60	72	COMBI7	16°	TCG	242,00 €
282.072.18W2	450	4.8	3.5	80	72	COMBI5	16°	TCG	242,00 €

*Diğer ölçüler için lütfen iletişime geçin.

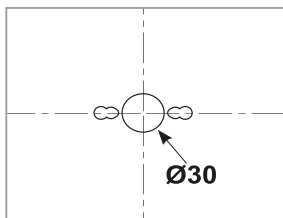

COMBI3
2/7/42mm
2/9/46,4mm
2/10/60mm

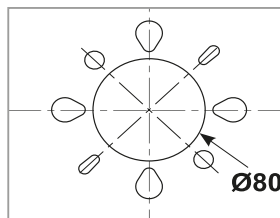

COMBI5
2/7/110mm
2/8,4/130mm
2/14/110mm
4/9/100mm
4/19/120mm
4/15/125mm

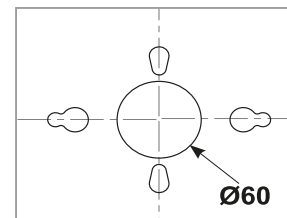

COMBI7
2/10/80mm
1/11/85mm
2/11/115mm
2/11/148mm
2/14/100mm
2/14/125mm
2/19/120mm

*Fiyatlarımıza KDV Dahil Değildir.

*Diğer ölçüler için lütfen iletişime geçin.

XTRME

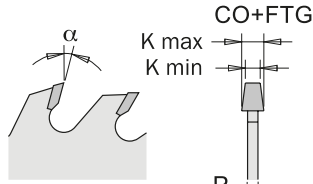
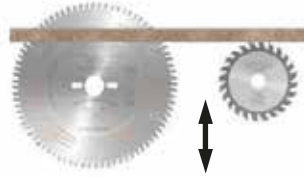

PANEL EBATLAMA ÇİZİCİ TESTERELER

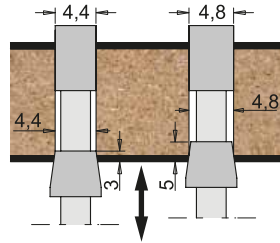

Order No.	D	K	P	d	Z	PiN	α	β	Fiyat
288.125.24H2	125	3.1-5.5	3.2	20	24		10°	CO+FTG	82,50 €
288.125.24Q	125	4.3-5.5	3.2	45	24		10°	CO+FTG	82,50 €
288.150.36Y	150	4.4-5.6	3.2	30	36		10°	CO+FTG	93,50 €
288.160.36Q	160	4.3-5.5	3.2	45	36	3/11/70	10°	CO+FTG	110,00 €
288.160.36O	160	4.3-5.5	3.2	55	36	3/7/66 + 3/6/84	10°	CO+FTG	110,00 €
288.180.36M	180	4.4-5.3	3.2	30	36		10°	CO+FTG	121,00 €
288.180.44T	180	4.3-5.5	3.2	50	44	3/13/80	10°	CO+FTG	121,00 €
288.200.36H	200	4.4-5.3	3.2	20	36		10°	CO+FTG	121,00 €
288.200.36J	200	4.4-5.3	3.2	65	36	2/9/100 + 2/9/110	10°	CO+FTG	121,00 €
288.180.36Q	180	4.8-5.6	3.5	45	36		10°	CO+FTG	121,00 €
288.200.36Q	200	4.7-6.0	3.5	45	36		10°	CO+FTG	121,00 €

*Diğer ölçüler için lütfen iletişime geçin.

MAKİNA MODEL	ANA TESTERE ÇAPLARI	ELMAS KALINLIĞI	GÖBEK DELİĞİ	PİN DELİĞİ
GABBIANI ANA TESTERE	350+355+380+400+420+450	4,4	80	2/7/110 + 2/14/110
GABBIANI ÇİZİCİ TESTERE	160+200	4,4	55/80	3/7/66+3/6/84 + 2/14/110
GİBEN ANA TESTERE	350+380+400+430	4,4	50 + 75	4/13/80 + 4/15/105 + (2/7/110)
GİBEN ÇİZİCİ TESTERE	125+160+180+200+215	4,4	45 + 50	3/13/70 + 3/13/80 + (2/7/80)
BIESSE-SELCO ANA TESTERE	355+400+430+450	4,4 - 4,8	65 + 80	2/9/110 + 4/19/120 + 4/11/130
BIESSE-SELCO ÇİZİCİ TESTERE	200	4,4 - 4,8	65	2/9/100 + 2/9/110
HOMAG-HOLZMA ANA TESTERE	350+380+450	4,4 - 4,8	60	2/14/100 + 2/14/125
HOMAG-HOLZMA ÇİZİCİ TESTERE	180+200	4,4 - 4,8	45	0 + (2/10/60)
SCM, MAYER, HOLZHER, CASADEI ANA TESTERE	300+320+350+355	4,4	30	2/10/60 + 2/7/42 (2/14/110)
SCM, MAYER, HOLZHER, CASADEI ÇİZİCİ TESTERE	125+150+180+200	4,4	30	0
TURANLAR ANA TESTERE	300+320+350+400+430+450	4,4	30 + 80	2/10/60 + 2/15/125 + (2/13/94)
TURANLAR ÇİZİCİ TESTERE	150+180+200	4,4	30 + 65	02/10/60 + (2/11/110)
TÖRK ANA TESTERE	320	4,4	75	3/7/100
TÖRK ÇİZİCİ TESTERE	160	4,4	55	3/7/66+3/6/84

*Diğer ölçüler için lütfen iletişime geçin.

*Fiyatlarımıza KDV Dahil Değildir.



PANEL EBATLAMA TESTERELER ÖLÇÜ BELİRLEME ŞABLONU

2 DELİKLİ

PİN DELİK ÇAPI :
GÖBEK DELİK ÇAPI :
PİN DELİK AKS ARASI :

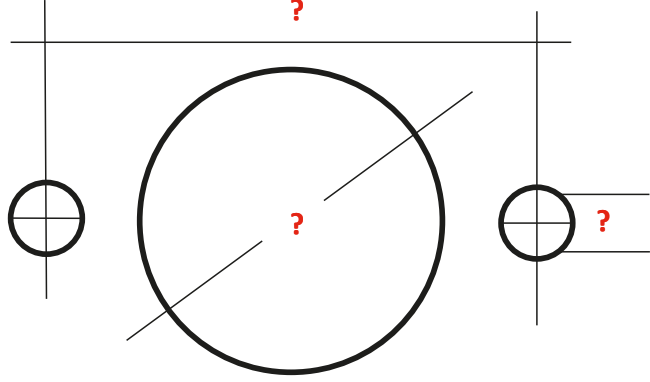

3 DELİKLİ

PİN DELİK ÇAPI :
GÖBEK DELİK ÇAPI :
PİN DELİK AKS ARASI :

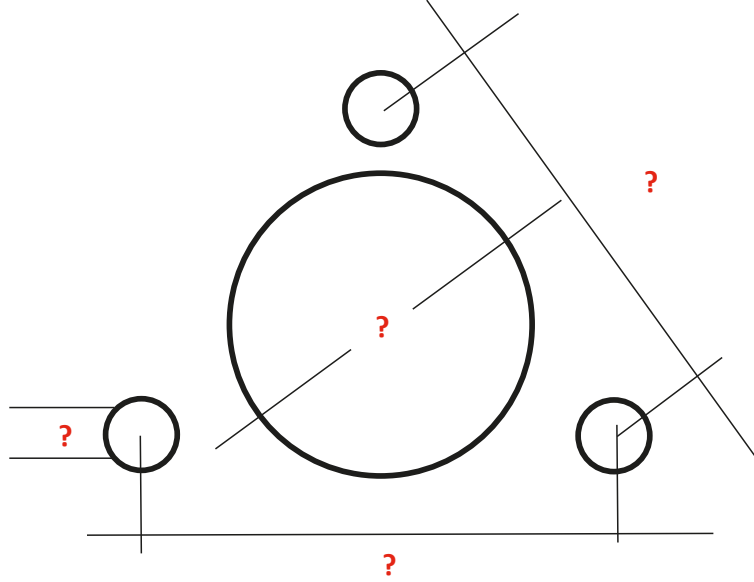

4 DELİKLİ

PİN DELİK ÇAPI :
GÖBEK DELİK ÇAPI :
PİN DELİK AKS ARASI :

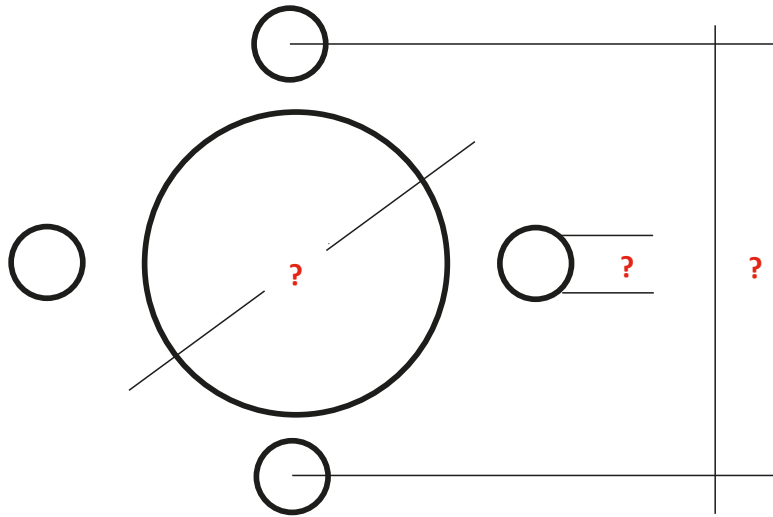

MATKAP UÇLARI

CMT ORANGE
TOOLS®





ORMEND
MAKİNA SAN. TIC. LTD. ŞTİ.

MATKAP UÇLARI

YARIM DELİK MATKAP UÇLARI (KISA)

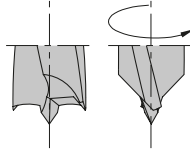
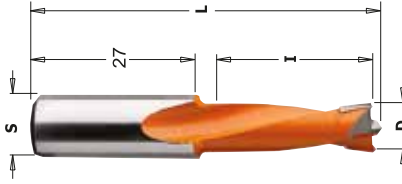

Order No. LH	Order No. RH	D	I	L	S	Fiyat
310.040.12	310.040.11	4	27	57.5	10x27	14,00 €
310.050.12	310.050.11	5	27	57.5	10x27	11,00 €
310.060.12	310.060.11	6	27	57.5	10x27	11,40 €
310.070.12	310.070.11	7	27	57.5	10x27	12,60 €
310.080.12	310.080.11	8	27	57.5	10x27	12,50 €
310.090.12	310.090.11	9	27	57.5	10x27	13,90 €
310.100.12	310.100.11	10	27	57.5	10x27	13,90 €
310.110.12	310.110.11	11	27	57.5	10x27	15,00 €
310.120.12	310.120.11	12	27	57.5	10x27	15,00 €

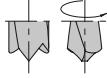
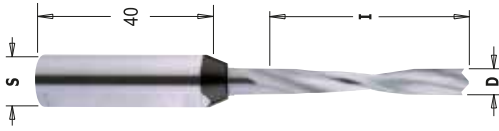

X-TREME

YARIM DELİK MATKAP UÇLARI (İNCE/UZUN)

Order No. LH	Order No. RH	D	I	L	S	Fiyat
311.030.22	311.030.21	3	18	70	10x40	18,20 €
311.035.22	311.035.21	3.5	18	70	10x40	19,80 €
311.040.22	311.040.21	4	27	70	10x29	19,80 €
311.050.22	311.050.21	5	30	70	10x28	20,90 €

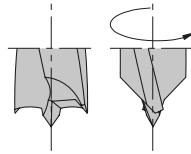
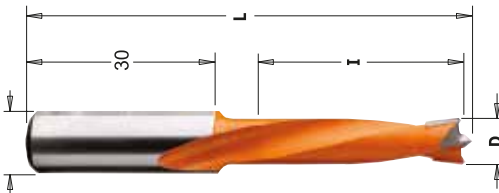

YARIM DELİK MATKAP UÇLARI (UZUN)

Order No. LH	Order No. RH	D	I	L	S	Fiyat
311.040.12	311.040.11	4	35	70	10x30	14,30 €
311.050.12	311.050.11	5	35	70	10x30	11,60 €
311.060.12	311.060.11	6	35	70	10x30	12,50 €
311.070.12	311.070.11	7	35	70	10x30	13,00 €
311.080.12	311.080.11	8	35	70	10x30	12,70 €
311.090.12	311.090.11	9	35	70	10x30	14,50 €
311.100.12	311.100.11	10	35	70	10x30	14,50 €
311.110.12	311.110.11	11	35	70	10x30	15,40 €
311.120.12	311.120.11	12	35	70	10x30	15,40 €

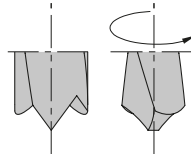
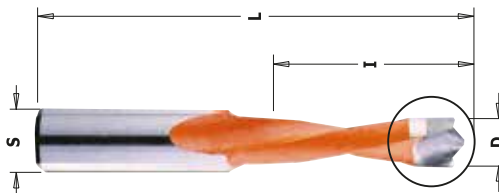

X-TREME

YARIM DELİK MATKAP UÇLARI (UZUN)

Order No. LH	Order No. RH	D	I	L	S	Fiyat
311.080.42	311.080.41	8	35	70	10x30	14,30 €

*Fiyatlarımıza KDV Dahil Değildir.

*Diğer ölçüler için lütfen iletişime geçin.

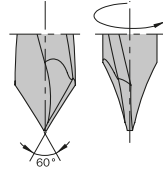
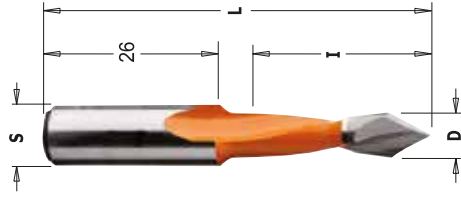

TAM DELİK MATKAP UÇLARI (KISA)

Order No. LH	Order No. RH	D	I	L	S	Fiyat
313.050.12	313.050.11	5	27	57.5	10x26	14,50 €
313.080.12	313.080.11	8	27	57.5	10x26	16,00 €
313.100.12	313.100.11	10	27	57.5	10x26	17,60 €

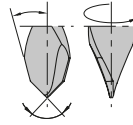
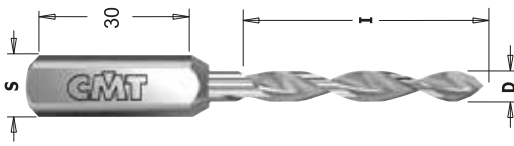

TAM DELİK MATKAP UÇLARI (İNCE/UZUN)



Order No. LH	Order No. RH	D	I	L	S	Fiyat
314.030.22	314.030.21	3	27	70	10x30	19,30 €
314.040.22	314.040.21	4	35	70	10x26	20,40 €
314.050.22	314.050.21	5	35	70	10x26	21,50 €

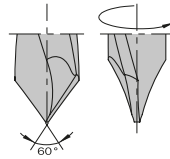
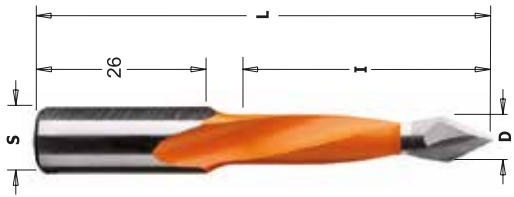

TAM DELİK MATKAP UÇLARI (UZUN)

Order No. LH	Order No. RH	D	I	L	S	Fiyat
314.040.12	314.040.11	4	30	70	10x26	18,00 €
314.050.12	314.050.11	5	35	70	10x26	15,40 €
314.060.12	314.060.11	6	35	70	10x26	16,00 €
314.070.12	314.070.11	7	35	70	10x26	17,60 €
314.080.12	314.080.11	8	35	70	10x26	18,20 €
314.090.12	314.090.11	9	35	70	10x26	18,20 €
314.100.12	314.100.11	10	35	70	10x26	18,20 €
314.120.12	314.120.11	12	35	70	10x26	20,90 €

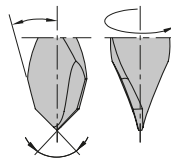
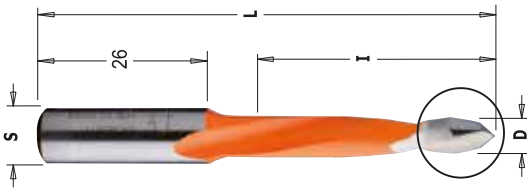

TAM DELİK MATKAP UÇLARI (UZUN)



Order No. LH	Order No. RH	D	I	L	S	Fiyat
314.080.42	314.080.41	8	35	70	10x26	19,80 €

*Diğer ölçüler için lütfen iletişime geçin.

*Fiyatlarımıza KDV Dahil Değildir.

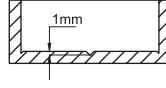
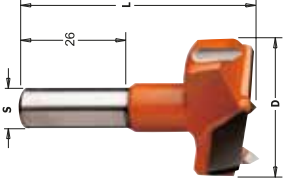

MENTEŞE MATKAP UÇLARI (KISA)

Order No. LH	Order No. RH	D	I	L	S	Fiyat
317.150.12	317.150.11	15		57,5	10x26	22,60 €
317.160.12	317.160.11	16		57,5	10x26	22,60 €
317.180.12	317.180.11	18		57,5	10x26	23,60 €
317.200.12	317.200.11	20		57,5	10x26	23,60 €
317.250.12	317.250.11	25		57,5	10x26	26,80 €
317.260.12	317.260.11	26		57,5	10x26	26,80 €
317.300.12	317.300.11	30		57,5	10x26	28,60 €
317.350.12	317.350.11	35		57,5	10x26	28,60 €

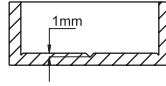
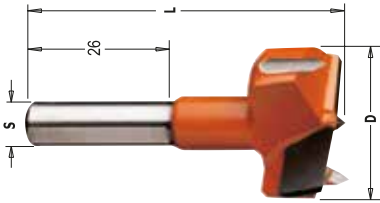

MENTEŞE MATKAP UÇLARI (UZUN)

Order No. LH	Order No. RH	D	I	L	S	Fiyat
369.150.12	369.150.11	15		70	10x26	24,20 €
369.160.12	369.160.11	16		70	10x26	25,30 €
369.180.12	369.180.11	18		70	10x26	26,40 €
369.200.12	369.200.11	20		70	10x26	26,40 €
369.220.12	369.220.11	22		70	10x26	27,50 €
369.250.12	369.250.11	25		70	10x26	27,50 €
369.260.12	369.260.11	26		70	10x26	28,60 €
369.300.12	369.300.11	30		70	10x26	30,80 €
369.350.12	369.350.11	35		70	10x26	31,40 €

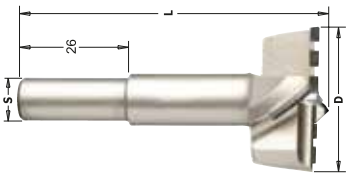

20X
UZUN ÖMÜR

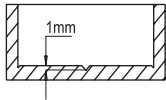

DIA MENTEŞE MATKAP UÇLARI (KISA & UZUN)

Order No. LH	Order No. RH	D	I	L	S	Fiyat
317.150.62	317.150.61	15		57,5	10x26	349,00 €
317.350.62	317.350.61	35		57,5	10x26	393,00 €

Order No. LH	Order No. RH	D	I	L	S	Fiyat
369.150.62	369.150.61	15		70	10x26	349,00 €
369.350.62	369.350.61	35		70	10x26	393,00 €

*Fiyatlarımıza KDV Dahil Değildir.

*Diğer ölçüler için lütfen iletişime geçin.

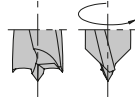
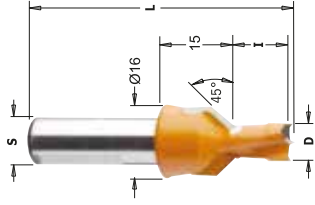

HAVŞALI DÜBEL MATKAP UÇLARI (KISA/UZUN)

Order No. LH	Order No. RH	D	I	L	S	Fiyat
376.080.12	376.080.11	8	12	57.5	10	22,00 €
376.081.12	376.081.11	8	15	57.5	10	22,00 €
376.082.12	376.082.11	8	20	57.5	10	22,00 €

Order No. LH	Order No. RH	D	I	L	S	Fiyat
377.080.12	377.080.11	8	12	70	10	22,00 €
377.081.12	377.081.11	8	15	70	10	22,00 €
377.082.12	377.082.11	8	20	70	10	22,00 €

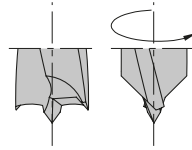
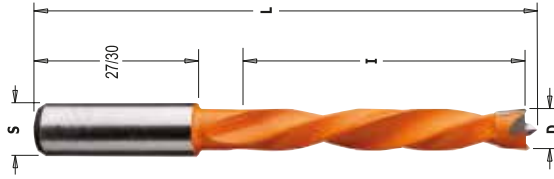

YARIM DELİK MATKAP UÇLARI (UZUN 4 HELİSLİ)

Order No. LH	Order No. RH	D	I	L	S	Fiyat
373.080.12	373.080.11	8	50	85	10x27	16,50 €
373.100.12	373.100.11	10	50	85	10x27	18,20 €
373.120.12	373.120.11	12	50	85	10x27	20,40 €

Order No. LH	Order No. RH	D	I	L	S	Fiyat
372.080.12	372.080.11	8	65	105	10x30	18,70 €
372.100.12	372.100.11	10	65	105	10x30	20,90 €
372.120.12	372.120.11	12	65	105	10x30	23,10 €

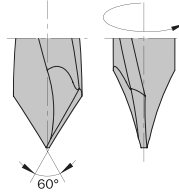
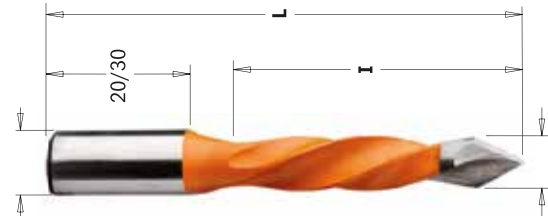

TAM DELİK MATKAP UÇLARI (UZUN 4 HELİSLİ)

Order No. LH	Order No. RH	D	I	L	S	Fiyat
381.050.11	381.050.12	5	70	115	10X30	23,10 €
381.080.11	381.080.12	8	70	115	10X30	24,20 €
381.100.11	381.100.12	10	70	115	10X30	25,30 €

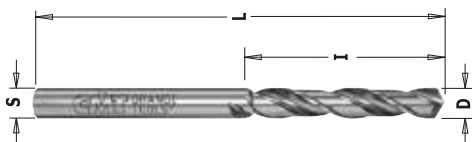

SOLID HM MATKAP UÇLARI

Order No. LH	Order No. RH	D	I	L	S	Fiyat
363.025.12	363.025.11	2.5	27	55	2.5	9,90 €
363.030.12	363.030.11	3	27	55	3	11,00 €
363.035.12	363.035.11	3.5	27	55	3.5	13,20 €

*Fiyatlarımıza KDV Dahil Değildir.

*Diğer ölçüler için lütfen iletişime geçin.

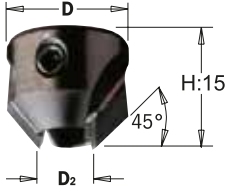

HAVŞALAR

Order No. LH	Order No. RH	D ₂	D	H	Açı	Fiyat
316.040.12	316.040.11	4	16	15	45°	20,90 €
316.050.12	316.050.11	5	16	15	45°	20,90 €
316.060.12	316.060.11	6	16	15	45°	20,90 €
316.070.12	316.070.11	7	16	15	45°	20,90 €
316.080.12	316.080.11	8	18	15	45°	20,90 €
316.090.12	316.090.11	9	18	15	45°	20,90 €
316.100.12	316.100.11	10	20	15	45°	20,90 €
316.120.12	316.120.11	12	20	15	45°	20,90 €

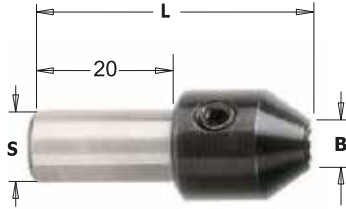

SOLID HM MATKAP UCU ADAPTÖRÜ

Order No.	B	L	S	Fiyat
364.025.00	2,5	38	10x20	11,00 €
364.030.00	3	38	10x20	11,00 €
364.035.00	3,5	38	10x20	11,00 €

MATKAP UCU KOVANI



Order No.	B	L	S	Fiyat
365.025.00	2,5	23	10	9,90 €
365.030.00	3	23	10	9,90 €
365.035.00	3,5	23	10	9,90 €



M10 ŞAFTLI DÜBEL MATKAP UÇLARI

*Diğer ölçüler için lütfen iletişime geçin.

Order No. LH	Order No. RH	D	I	LB	L	S	Fiyat
339.050.12	339.050.11	5	40	55	70	M10 (11+4)	30,30 €
339.080.12	339.080.11	8	40	55	70	M10 (11+4)	31,40 €
339.100.12	339.100.11	10	40	55	70	M10 (11+4)	31,40 €

*Fiyatlarımıza KDV Dahil Değildir.

*Diğer ölçüler için lütfen iletişime geçin.

DELİK GRUBU ADAPTÖRLERİ



Order No.	B	d	D	H	Fiyat
360.101.00	10	17.5	18	42	17,60 €

Vitap

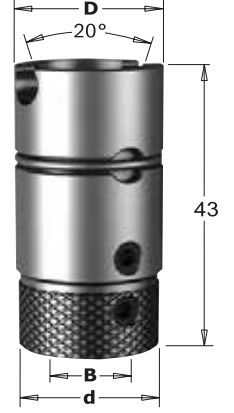

Order No.	B	d	D	H	Fiyat
360.201.00	10	19.5	20	43	22,00 €

Morbidelli



Order No.	B	d	D	H	Fiyat
360.301.00	10	19.5	20	40	22,00 €

Masterwood, Maggi, Griggio



Order No. RH	Order No. LH	B	d	D	H	Fiyat
360.001.01	360.001.02	10	20	15	40	17,60 €

Biesse



Order No. RH	Order No. LH	B	D	S	H	Fiyat
358.000.01	358.000.02	10	19.5	M8/9	40	8,80 €

Masterwood, Morbidelli

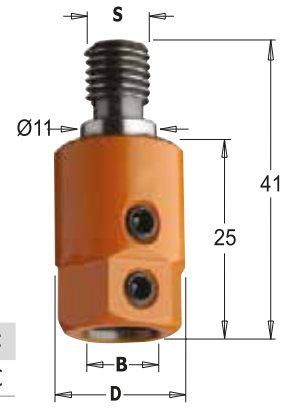

Order No. RH	Order No. LH	B	D	S	H	Fiyat
305.000.01	305.000.02	10	19.5	M10/11	41	8,80 €

Biesse, Masterwood, Morbidelli, Vitap, Weeke

*Diğer ölçüler için lütfen iletişime geçin.

*Fiyatlarımıza KDV Dahil Değildir.



CNC ADAPTÖRLER

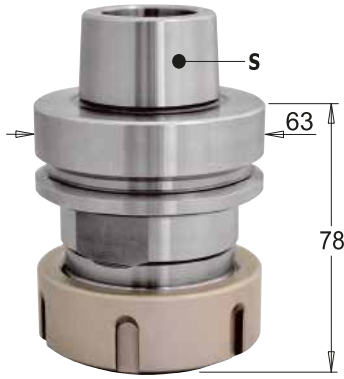

HSK-63F ER40

Order No. RH	Fiyat
183.310.01	93,50 €



HSK-63F ER32

Order No. RH	Fiyat
183.300.01	88,00 €



ISO30 ER40

Order No. RH	Fiyat
183.201.01	93,50 €



ISO30 ER32

Order No. RH	Fiyat
183.200.01	84,00 €

PENSLER



184 - ER40

Order No.	Fiyat
184.002.00	15,50 €

4mm - 25mm'ye kadar.



184 - ER32

Order No.	Fiyat
184.000.00	14,50 €

3mm - 20mm'ye kadar.



184 - ER25

Order No.	Fiyat
184.000.25	12,50 €

3mm - 16mm'ye kadar.

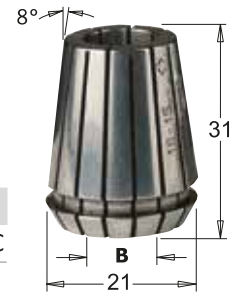

184 - ER20

Order No.	Fiyat
184.000.20	12,50 €

2mm - 12mm'ye kadar.

*Fiyatlarımıza KDV Dahil Değildir.

*Diğer ölçüler için lütfen iletişime geçin.



KINETIC
DUST EXTRACTOR

CNC KİNETİK TOZ EMİCİ

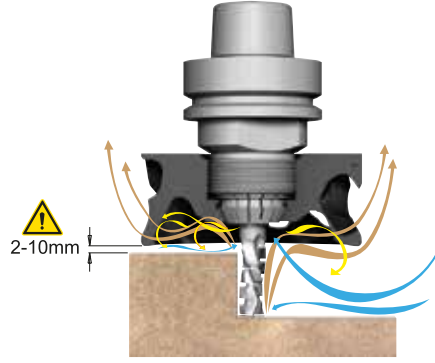

Order No.	D	Fiyat
992.101.ER32	100	440,00 €
992.101.ER40	100	440,00 €



VİDEO İZLE



*Diğer ölçüler için lütfen iletişime geçin.

*Fiyatlarımıza KDV Dahil Değildir.



ADAPTÖR SOMUNU



ER 40

Order No.	Fiyat
992.383.01	16,50 €

ER 32

Order No.	Fiyat
992.183.01	16,50 €



MONTAJ DESTEĞİ

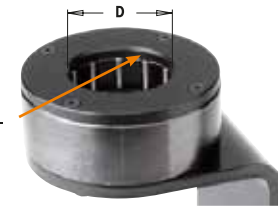

Order No.	D	Fiyat
183-HSK	63	281,00 €
183-ISO	50	281,00 €

ANAHTAR



Order No.		Fiyat
991.183.00	ER 32	23,50 €
991.184.00	ER 40	25,30 €

FREZELER

CMT ORANGE
TOOLS®



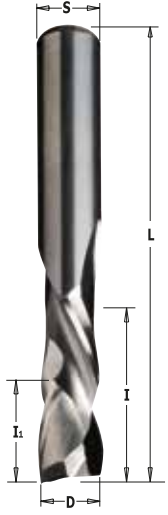

HWM

NEGATİF / POZİTİF ALT ÜST HASSAS KESİM

Order No.	D mm	I mm	I ₁ mm	L mm	S mm	Z	Fiyat
190.040.11	4	15	7	50	4	1+1	24,20 €
190.050.11	5	22	8	60	5	1+1	31,00 €
190.060.11	6	22	8	60	6	1+1	33,00 €
190.080.11	8	32	7	80	8	2+2	63,00 €
190.100.11	10	32	7	80	10	2+2	89,00 €
190.101.11	10	42	7	90	10	2+2	94,00 €
190.120.11	12	42	7	90	12	2+2	127,00 €
190.121.11	12	52	7	100	12	2+2	132,00 €
190.160.11	16	55	24	110	16	2+2	218,00 €
190.180.11	18	55	30	110	18	2+2	292,00 €



HWM

HASSAS KESİM

Order No.	D mm	I mm	L mm	S mm	Z	Fiyat
193.081.11	8	32	80	8	3	47,00 €
193.100.11	10	32	80	10	3	70,00 €
193.101.11	10	42	90	10	3	85,00 €
193.120.11	12	35	83	12	3	95,00 €
193.121.11	12	42	90	12	3	108,00 €
193.122.11	12	52	100	12	3	114,00 €
193.140.11	14	58	110	14	3	152,00 €
193.160.11	16	55	110	16	3	193,00 €
193.161.11	16	35	90	16	3	160,00 €
193.165.11	16	72	120	16	3	207,00 €
193.180.11	18	55	110	18	3	245,00 €
193.200.11	20	60	120	20	3	275,00 €
193.201.11	20	70	120	20	3	284,00 €

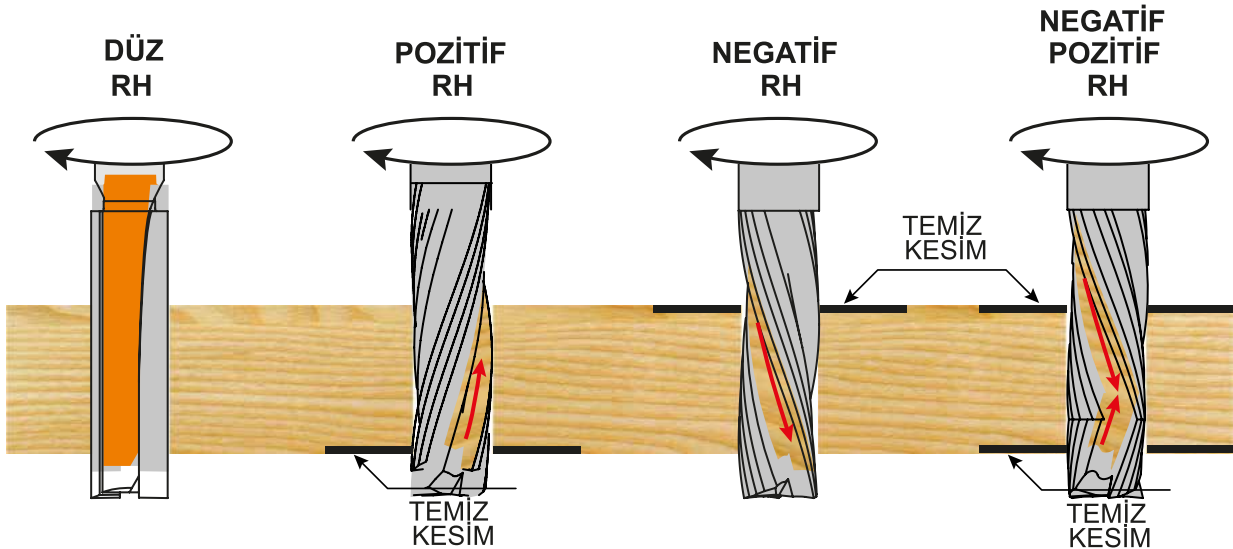

*Fiyatlarımıza KDV Dahil Değildir.

*Diğer ölçüler için lütfen iletişime geçin.

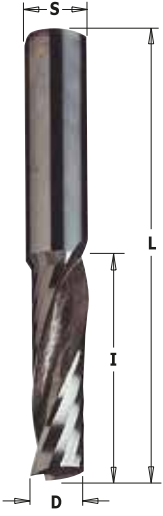

HWM

PVC & PLEKSİ KESİM

Order No.	D mm	I mm	L mm	S mm	Z	Fiyat
198.030.11	3	12	50	3	1	22,00 €
198.040.11	4	15	50	4	1	25,00 €
198.050.11	5	17	50	5	1	30,00 €
198.060.11	6	22	60	6	1	38,00 €
198.080.11	8	22	70	8	1	42,00 €
198.081.11	8	32	80	8	1	44,00 €
198.100.11	10	32	70	10	1	64,00 €
198.101.11	10	42	80	10	1	66,00 €
198.102.11	10	52	90	12	1	73,00 €
198.120.11	12	32	83	10	1	89,00 €

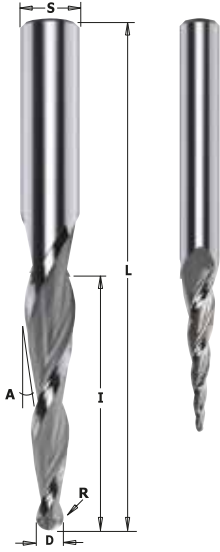

HWM

2D / 3D KESİM

Order No.	D mm	R mm	A	I mm	L mm	S mm	Z	Fiyat
152.060.082	0,8	0,4	5,5°	25	70	6	3	42,00 €
152.064.082	0,8	0,4	6,2°	25,4	76,2	6,35	3	42,00 €
152.060.162	1,6	0,8	4,5°	25	70	6	3	42,00 €
152.064.162	1,6	0,8	5,4°	25,4	76,2	6,35	3	42,00 €
152.080.163	1,6	0,8	5,5°	30	80	8	3	47,00 €
152.120.208	2	1	3°	80	120	12	2	135,00 €
152.060.323	3,2	1,6	2,5°	30	70	6	3	44,00 €
152.064.322	3,2	1,6	3,6°	25,4	76,2	6,35	3	44,00 €
152.080.325	3,2	1,6	2,5°	50	90	8	3	60,00 €
152.120.605	6	3	3°	50	100	12	2	105,00 €
152.127.635	6,4	3,2	3°	50,8	101,6	12,7	2	127,00 €

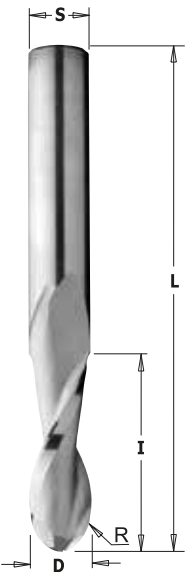

HWM

KÜRE KESİM

Order No.	D mm	R mm	I mm	L mm	S mm	Z	Fiyat
199.060.11	6	3	27	70	6	2	37,00 €
199.081.11	8	4	32	80	8	2	43,00 €
199.100.11	10	5	32	80	10	2	69,00 €
199.120.11	12	6	35	80	12	2	94,00 €
199.160.11	16	8	55	110	16	2	182,00 €

HWM Karbür Elmas.

*Diğer ölçüler için lütfen iletişime geçin.

*Fiyatlarımıza KDV Dahil Değildir.



HWM

KABA TALAŞ KESİM

Order No.	D mm	I mm	L mm	S mm	Z	Fiyat
195.081.11	8	32	80	8	3	51,00 €
195.082.11	8	42	90	8	3	63,00 €
195.100.11	10	32	80	10	3	74,00 €
195.101.11	10	42	90	10	3	91,00 €
195.120.11	12	35	83	12	3	99,00 €
195.121.11	12	42	90	12	3	114,00 €
195.122.11	12	52	100	12	3	119,00 €
195.140.11	14	58	110	14	3	165,00 €
195.160.11	16	55	110	16	3	207,00 €
195.161.11	16	35	90	16	3	171,00 €
195.165.11	16	72	120	16	3	220,00 €
195.180.11	18	55	110	18	3	253,00 €
195.200.11	20	60	120	20	3	253,00 €
195.201.11	20	72	120	20	3	294,00 €
195.202.11	20	102	165	20	3	374,00 €



HWM

KABA TALAŞ KESİM (KİLİT YERİ)

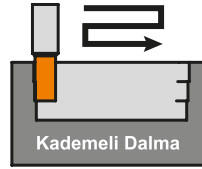

Order No.	D mm	I mm	I ₁ mm	L mm	S mm	Z	Fiyat
195.142.11	14	95	45	150	14	3	220,00 €
195.144.11	14	125	45	170	14	3	250,00 €
195.162.11	16	95	45	150	16	3	240,00 €
195.164.11	16	120	50	170	16	3	272,00 €
195.182.11	18	95	45	150	18	3	339,00 €

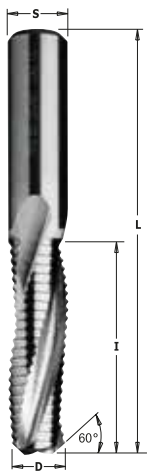

HWM

KABA TALAŞ KESİM (SİVRİ KOL ve GÖZ YERİ)

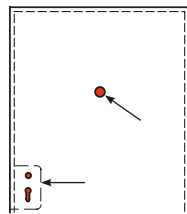
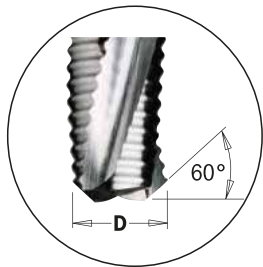

Order No.	D mm	I mm	I ₁ mm	L mm	S mm	Z	Fiyat
195.142.11	14	95	45	150	14	3	220,00 €
195.144.11	14	125	45	170	14	3	248,00 €
195.162.11	16	95	45	150	16	3	242,00 €
195.164.11	16	120	50	170	16	3	275,00 €
195.182.11	18	95	45	150	18	3	330,00 €

*Fiyatlarımıza KDV Dahil Değildir.

*Diğer ölçüler için lütfen iletişime geçin.

HWM Karbür Elmas.



40X
UZUN ÖMÜR



DİA 1+1 EBATLAMA FREZELER

Order No.	D mm	I mm	L mm	S mm	Z	Fiyat
140.120.61	12	27	75	12x40	1+1 (3 DP+1 HW)	127,00 €
140.121.61	12	35	85	12x40	1+1 (4 DP+1 HW)	173,00 €
140.161.61	16	35	93	16x50	1+1 (4 DP+1 HW)	173,00 €
140.181.61	18	35	95	20x50	1+1 (4 DP+1 HW)	173,00 €
140.182.61	18	45	105	20x50	1+1 (5 DP+1 HW)	215,00 €
140.201.61	20	35	95	20x50	1+1 (5 DP+1 HW)	173,00 €
140.203.61	20	55	115	20x50	1+1 (6 DP+1 HW)	259,00 €

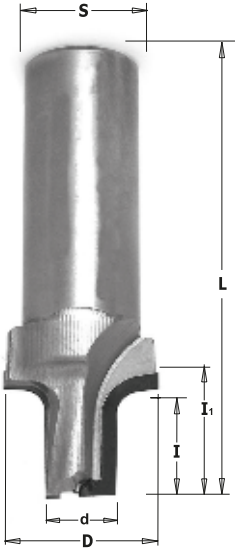

40X
UZUN ÖMÜR



DİA NESTİNG EBATLAMA FREZELER (MEBRAN RADÜS KAPAK)

Order No.	D mm	d mm	I mm	I ₁ mm	L mm	S mm	Z	R	Fiyat
NESTİNG	19	12	19	24	85	20x50	2+1	2-5	275,00 €



40X
UZUN ÖMÜR



DİA KANAL FREZELER

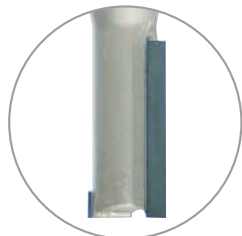

*141.101.61 Z1+1

Order No.	D mm	I mm	L mm	S mm	Z	Fiyat
141.060.61	6	8	65	12x40	1	116,00 €
141.080.61	8	12	65	12x40	1	138,00 €
S141.090.61	9	15	65	12x40	1	209,00 €
S141.091.61	9	15	65	12x40	2	319,00 €
*141.101.61	10	22	75	12x40	1+1	176,00 €

*Diğer ölçüler için lütfen iletişime geçin.

*Fiyatlarımıza KDV Dahil Değildir.

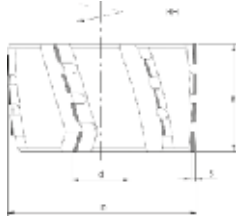

40X
UZUN ÖMÜR



DİA ÖN FREZELER

Order No. LH	Order No. RH	D	B	b	d	Z	Makina	Fiyat
10036533	10036534	85	45	45	30	3+3	Ott	Fiyat bilgisi için irtibata geçiniz.
10021305	10021304	100	34	37.6	30	3+3	IMA/Brant	Fiyat bilgisi için irtibata geçiniz.
10021307	10021306	100	48	40.6	30	2+2	IMA/Brant	Fiyat bilgisi için irtibata geçiniz.
10037003	10037004	100	48	25		2+2	HolzHer	Fiyat bilgisi için irtibata geçiniz.
10102851		125	43	40	30	3+3	Homag	Fiyat bilgisi için irtibata geçiniz.
10021303		125	63	40.6	30	3+3	Homag	Fiyat bilgisi için irtibata geçiniz.
10109727		125	42	47	30	3+3	Biesse	Fiyat bilgisi için irtibata geçiniz.
10028686	10028687	125	63	40.6	30	3+3	IMA	Fiyat bilgisi için irtibata geçiniz.

Order No. LH	Order No. RH	D	B	b	d	Z	Makina	Fiyat
1100068	1100069	100	65	40.6	30	3	IMA/Brant	Fiyat bilgisi için irtibata geçiniz.
1100102	1100103	125	48	40.6	30	3	IMA	Fiyat bilgisi için irtibata geçiniz.
1100112	1100113	125	65	42	30	3	IMA	Fiyat bilgisi için irtibata geçiniz.
1100030	1100031	80	43	22	30	3	IDM	Fiyat bilgisi için irtibata geçiniz.
1100072	1100073	100	65	25	30	3	HolzHer	Fiyat bilgisi için irtibata geçiniz.
1100098		125	43	47	30	3	Biesse	Fiyat bilgisi için irtibata geçiniz.
1100100		125	43	40.6	30	3	IMA/Homag	Fiyat bilgisi için irtibata geçiniz.
1100106		125	65	40.6	30	3	Homag	Fiyat bilgisi için irtibata geçiniz.

*Diğer tüm marka makinalar için lütfen iletişime geçin.



*Fiyatlarımıza KDV Dahil Değildir.

*Diğer ölçüler için lütfen iletişime geçin.

JİLETLİ MDF KAPAK MOTİF FREZE SETİ

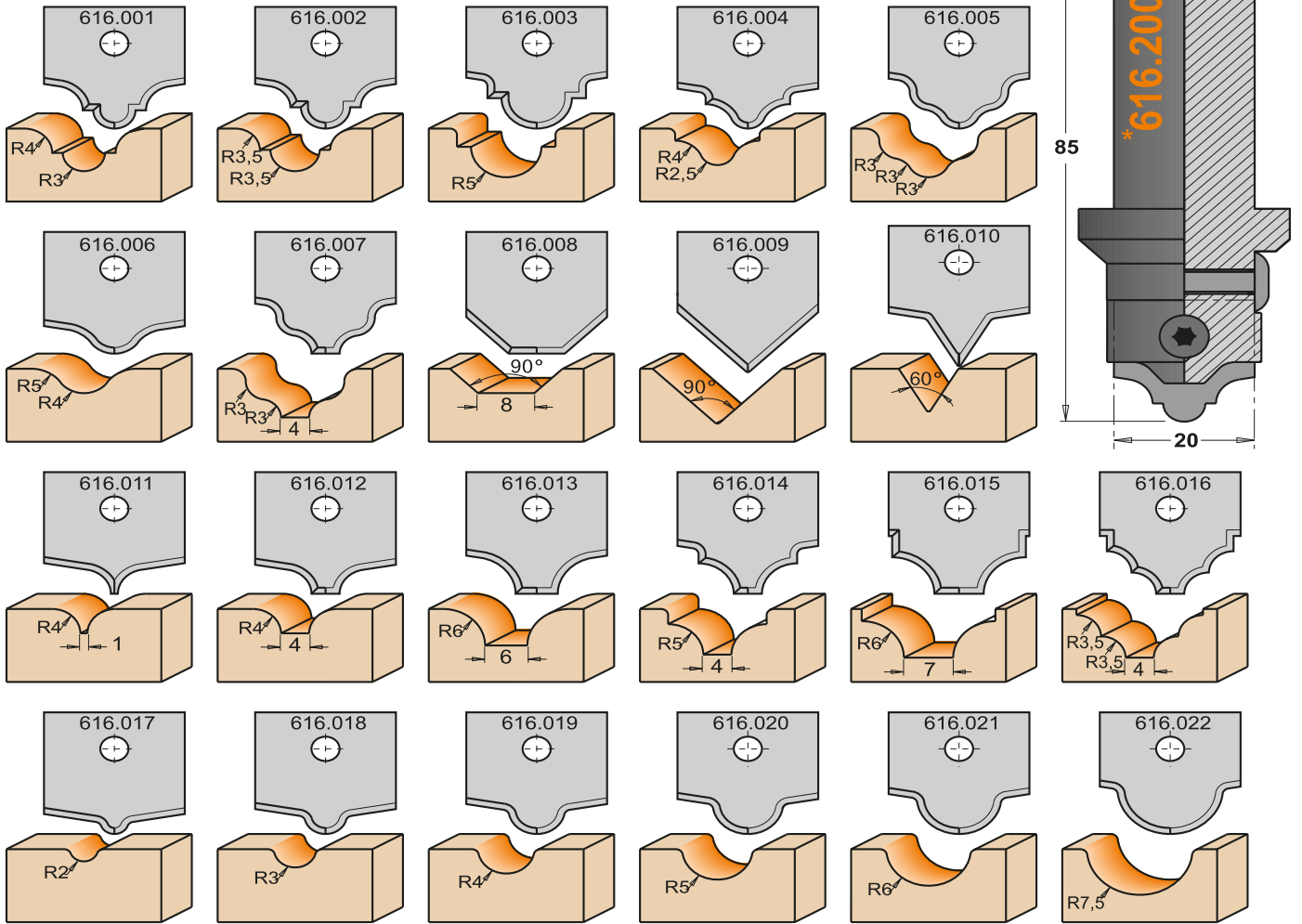

Order No.		Fiyat
616.000.01	SET (1 Adet sap, 22 adet jilet)	622,00 €
*616.200	FREZE SAPI (1 Adet freze sapı)	99,00 €
616.001-022	JİLET (İsteğe Göre 001-022 Arası Tek Olarak Jilet Sipariş Verilebilir.)	26,00 €

*Diğer ölçüler için lütfen iletişime geçin.

*Fiyatlarımıza KDV Dahil Değildir.



JİLETLİ MDF KAPAK MOTİF FREZE SETİ

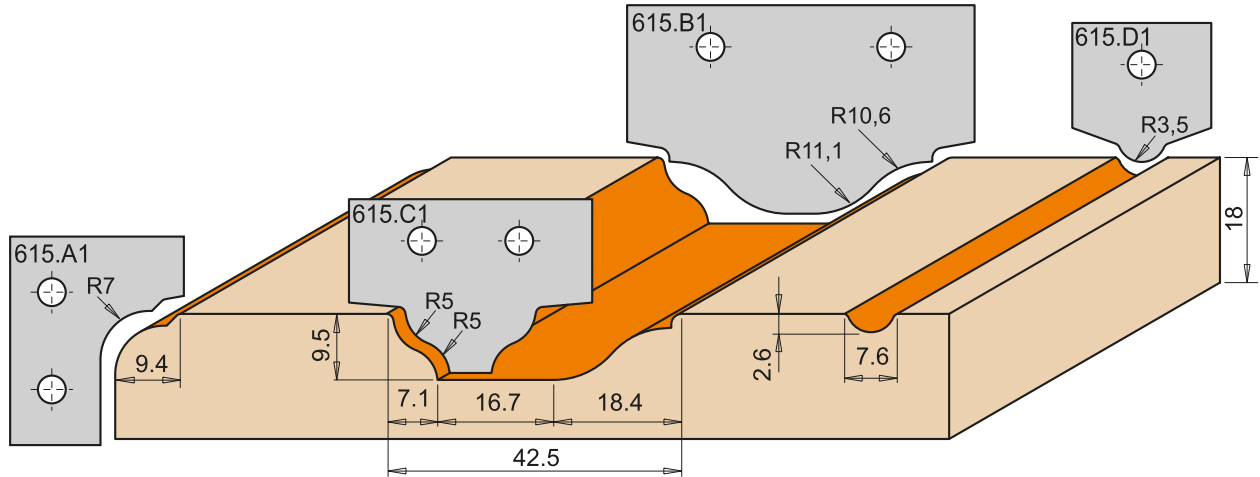
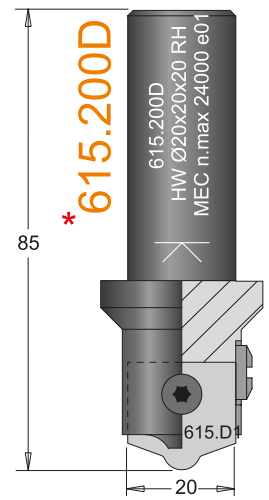
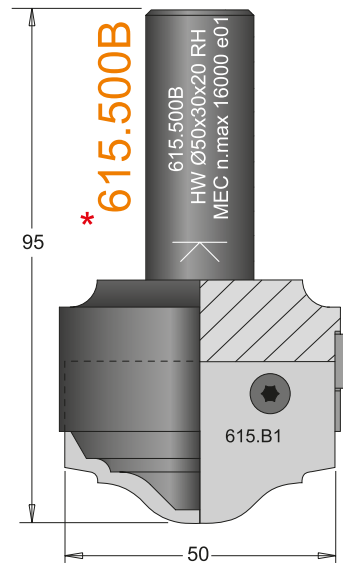
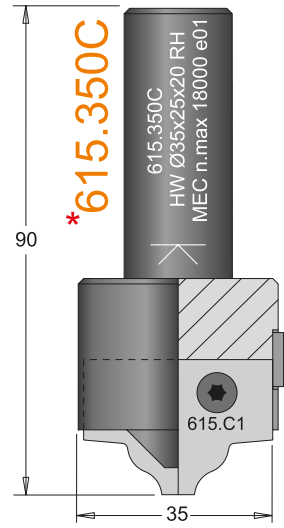
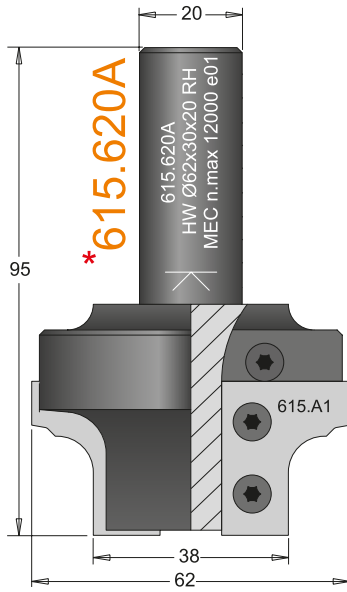

Order No.		Fiyat
615.004.01	SET (4 Adet Jiletli Freze)	792,00 €
*615.620A	FREZE SAPI (Jilet Hariç)	204,00 €
*615.350C	FREZE SAPI (Jilet Hariç)	149,00 €
*615.500B	FREZE SAPI (Jilet Hariç)	176,00 €
*615.200D	FREZE SAPI (Jilet Hariç)	105,00 €

*İsteğe Göre Ürün Kodu İle Tek Olarak Freze ve Jilet Sipariş Verilebilir.

*Diğer ölçüler için lütfen iletişime geçin.

*Fiyatlarımıza KDV Dahil Değildir.

JİLETLİ PARMAK FREZELER

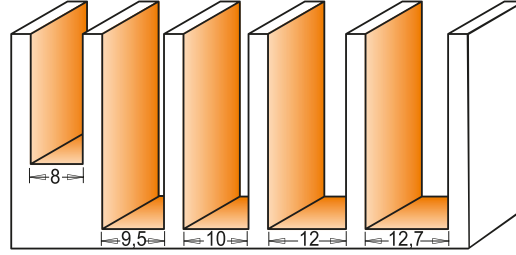
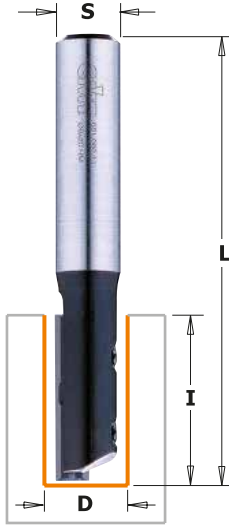

Order No.	D	I	L	S	Jilet Order No.	Jilet	Fiyat
651.080.11	8	20	60	8	790.200.01	20x4.1x1.1	69,00 €
651.081.11	8	20	67	12	790.200.01	20x4.1x1.1	72,00 €
651.695.11	9.5	30	80	12.7	790.300.01	30x5.5x1.1	72,00 €
651.101.11	10	30	80	12	790.300.01	30x5.5x1.1	72,00 €
651.121.11	12	30	80	12	790.300.01	30x5.5x1.1	77,00 €

JİLETLİ FREZELER

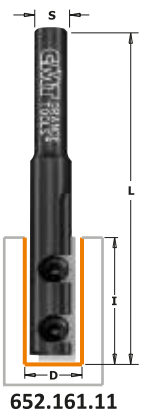

652.161.11



654.662.11



653.701.11



663.004.11



652.690.11B



657.993.11B



657.991.11

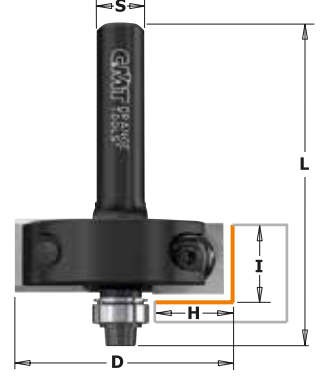

660.851.11



663.101.11

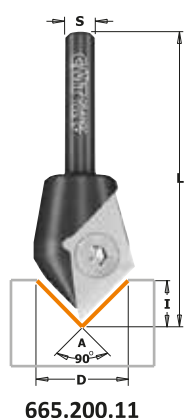

665.200.11

Order No.	D	I	L	S	Z	Jilet Order No.	Jilet	Fiyat
652.161.11	16	50	96	12	1	790.500.09	50x9x1.5	74,00 €
654.662.11	16	49.5	105	20	2	790.495.12	49,5x12x1,5	99,00 €
653.701.11	20	48.3	111	20	1+1	790.483.12 + 790.096.00	48.3x12x1.5 + 9.6x12x1.5	107,00 €
663.004.11	60	12	80	12	3	790.120.00	12x12x1.5	105,00 €
652.690.11B	19	49.5	100	12	1	790.495.09	49.5x9x1.5	77,00 €
657.993.11B	19	50	110	12	2	790.500.00	50x12x1,5	77,00 €
657.991.11	19	50	112	12	2	790.500.00	50x12x1,5	77,00 €
660.851.11	35	12	65	12,7	2	790.120.00	12x12x1,5	66,00 €
663.101.11	52	25	100	20	1	790.360.01	36x12x1.5	149,00 €
665.200.11	23	11	60	8	1	790.280.00	28x14x2	28,00 €

*Fiyatlarımıza KDV Dahil Değildir.

*Diğer ölçüler için lütfen iletişime geçin.



ELMAS FREZELER



915.690.11 / 915.380.11

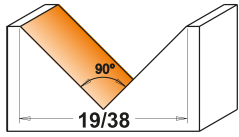

915.160.11B

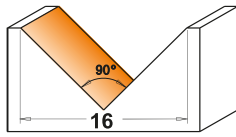

958.001.11

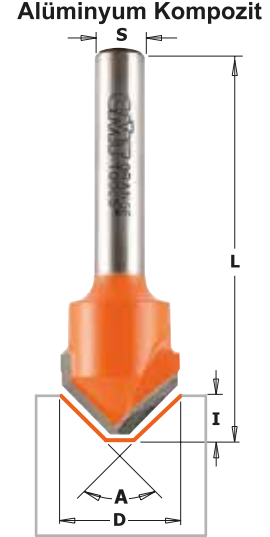
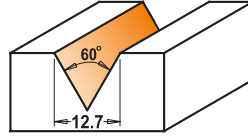

915.001.11

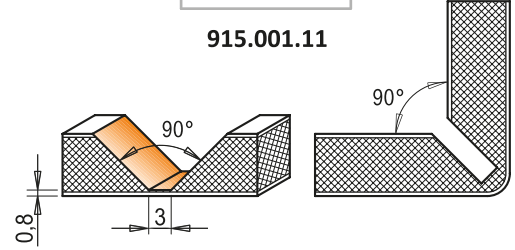

Kılavuzlu Panel Uç

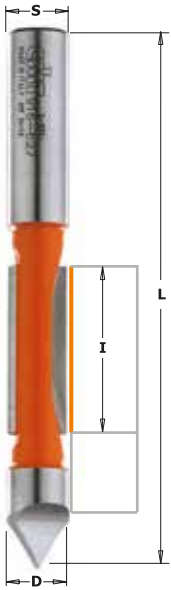

916.627.11

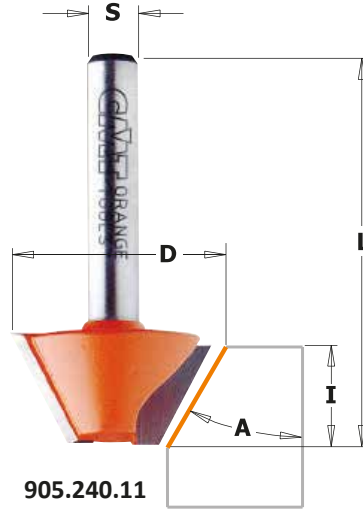
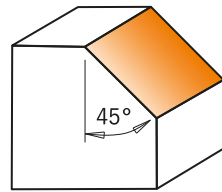

905.240.11

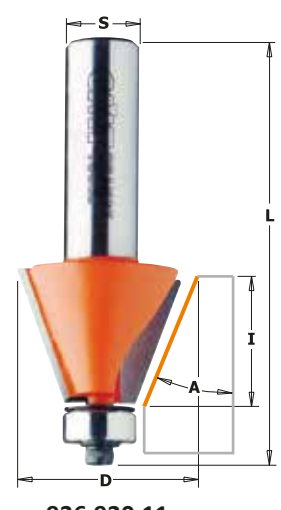

936.920.11



Order No.	D	I	I ₁	A	L	S	Z	Fiyat
915.690.11	19	16	9.5	90°	63.5	12	2	31,00 €
915.380.11	38	28.5	19	90°	63.5	8	2	54,00 €
915.160.11B	16	12.7	8	90°	53	8	2	39,00 €
958.001.11	12.7	11		60°	57.2	8	3	31,00 €
915.001.11	18	7.4		90°	60	8	2	38,00 €
916.627.11	12	31.7			102	12	2	32,00 €
905.240.11	25	8		45°	41	8	2	20,00 €
936.920.11	45	18		45°	67	12	2	37,00 €

*Fiyatlarımıza KDV Dahil Değildir.

HWM Karbür Elmas.

HW Çelik/Karbür.

*Diğer ölçüler için lütfen iletişime geçin.

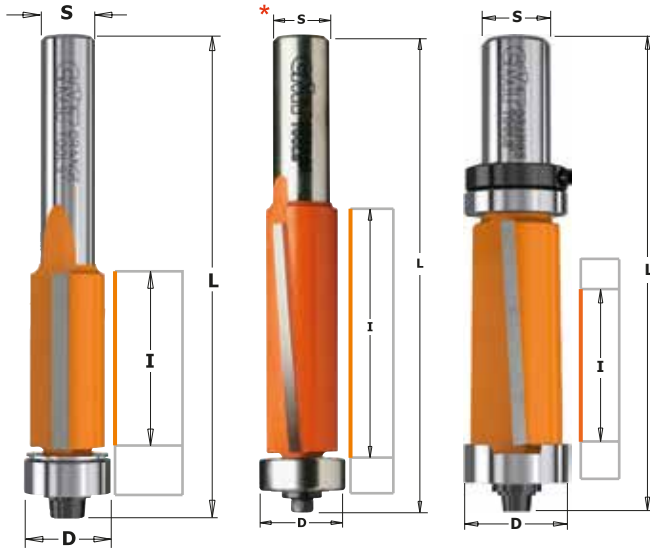

706.064.11
706.127.11

906.629.11
906.630.11

906.690.11B



BİLYALI TARAMA FREZELER

Order No.	D	I	A	L	S	Z	Fiyat
706.064.11	6.35	25.4	0°	64	6	2	28,00 €
706.127.11	12.7	25.4	-3°	71	6	2	26,00 €
906.629.11	12.7	38.1	0°	94	12	2	36,00 €
906.630.11	12.7	50.8	0°	104	12	2	38,00 €
*906.692.11	19	38.1	-3°	93	12	2	40,00 €
*906.690.11	19	50.8	-3°	110	12	2	44,00 €
906.690.11B	19	50,8	-3°	110	12	2	44,00 €

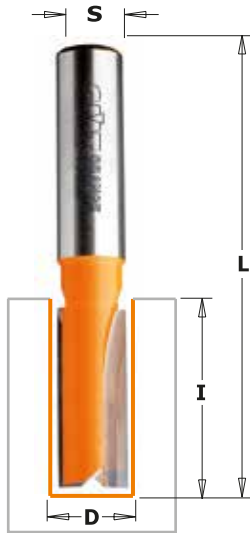

DÜZ TARAMA FREZELER



Order No.	D	I	A	L	S	Z	Fiyat
912.590.11	9	31.7	0°	75	12	2	27,00 €
912.600.11	10	31.7	0°	75	12	2	27,00 €
912.621.11	12	38.1	0°	95	12	2	28,00 €
912.622.11	12	50.8	0°	108	12	2	32,00 €
912.690.11	19	38,1	0°	82	12	2	29,00 €

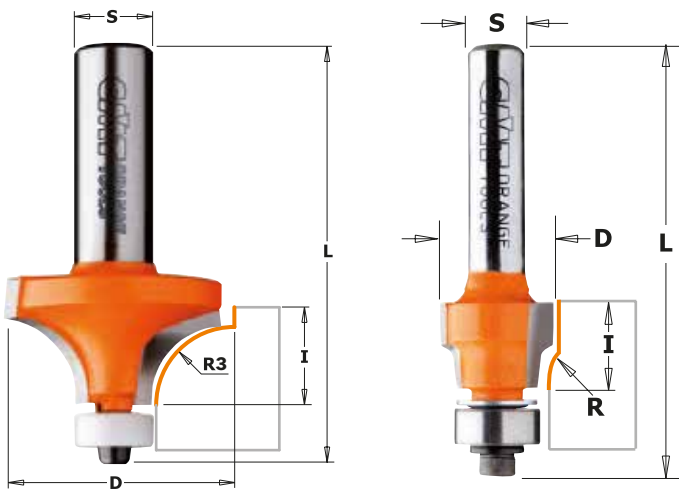

RADÜS TARAMA FREZELER

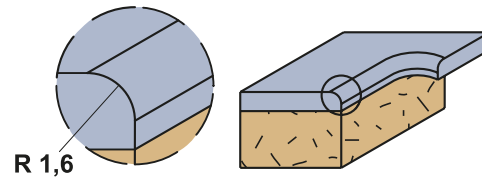

Order No.	D	I	R	L	S	Z	Fiyat
807.015.11	12.7	9.5	1,6	52	6.35	2	30,00 €
907.015.11	12.7	9.5	1,6	52	8	2	30,00 €
938.187.11	18.7	12.7	3	53	8	2	30,00 €

HWM Karbür Elmas.

HW Çelik/Karbür.

*Diğer ölçüler için lütfen iletişime geçin.

*Fiyatlarımıza KDV Dahil Değildir.



KANAL FREZELER

HWM

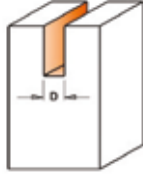

Order No.	D	I	L	S	Z	Fiyat
174.030.11	3	10	55	8	2+1	25,00 €
174.040.11	4	10	55	8	2+1	25,00 €
174.050.11	5	12	55	8	2+1	25,00 €
174.060.11	6	14	55	8	2+1	26,00 €
174.070.11	7	20	55	8	2+1	28,00 €

KAYNAKLI FREZELER

HW HWM

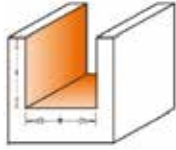

Order No.	D	I	L	S	Z	Fiyat
175.040.11	4	10	65	10	2+1	25,00 €
175.050.11	5	12	65	10	2+1	25,00 €
175.060.11	6	14	65	10	2+1	26,00 €
175.070.11	7	17	65	10	2+1	28,00 €
175.080.11	8	20	65	10	2+1	29,00 €
175.100.11	10	25	70	10	2+1	31,00 €
175.120.11	12	25	70	10	2+1	36,00 €

KAYNAKLI FREZELER

HW

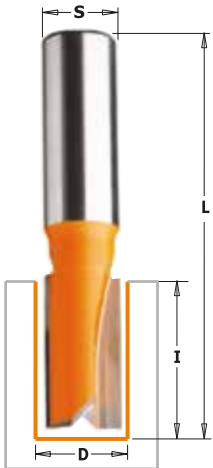

Order No.	D	I	L	S	Z	Fiyat
177.100.11	10	35	90	12	2+1	35,00 €
177.120.11	12	35	90	12	2+1	36,00 €
177.121.11	12	50	100	12	2+1	44,00 €
177.140.11	14	35	90	12	2+1	37,00 €
177.160.11	16	35	90	12	2+1	40,00 €
177.161.11	16	60	110	12	2+1	53,00 €
177.181.11	18	60	110	12	2+1	53,00 €

*Fiyatlarımıza KDV Dahil Değildir.

*Diğer ölçüler için lütfen iletişime geçin.

HWM Karbür Elmas.

HW Çelik/Karbür.



GÖNYELİ EKLEM FREZELER

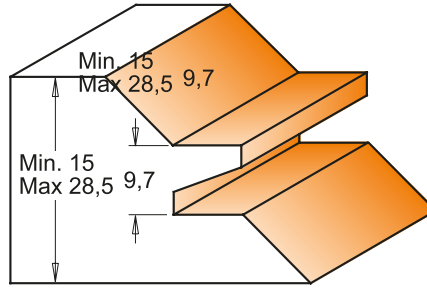
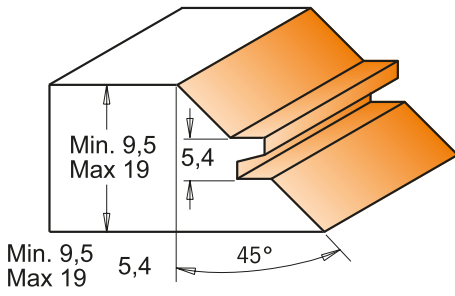
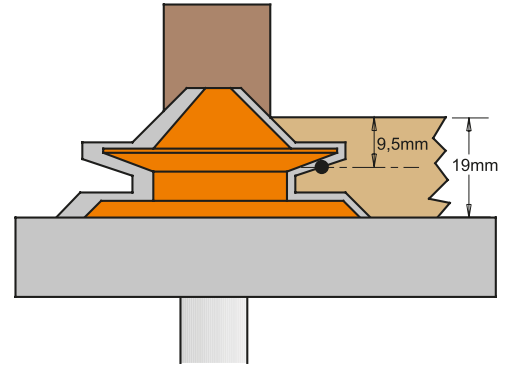
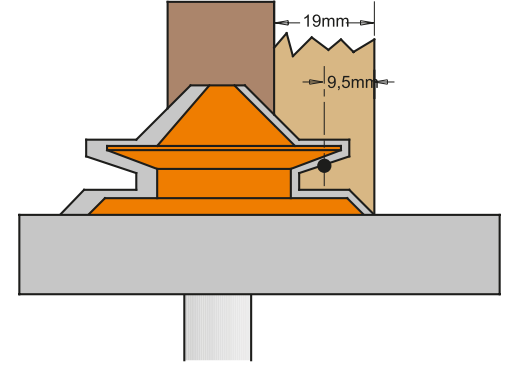
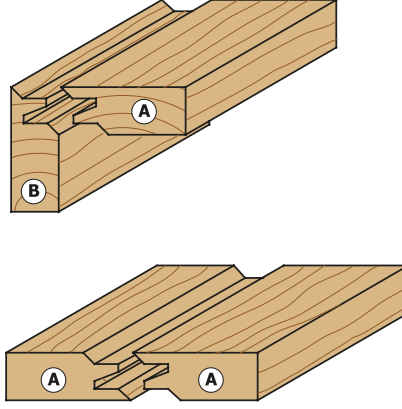
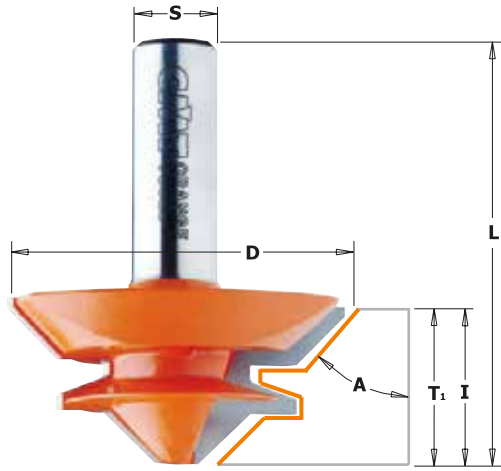

Order No.	D	I	A	L	S	T ₁	Z	Fiyat
955.503.11	70	31.7	45°	70	12	15 + 28.5	2	107,00 €
955.504.11	50.8	22.2	45°	60	12	9.5 + 19	2	79,00 €

GÖMME KULP FREZESİ

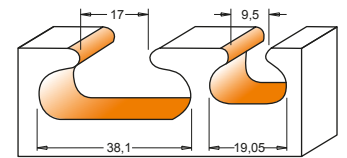
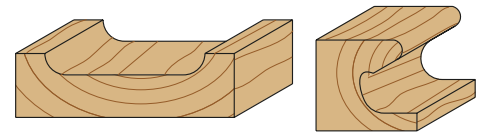
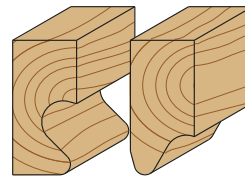
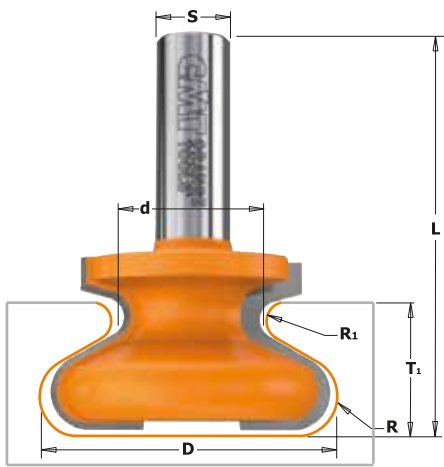

Order No.	D	d	T ₁	I	R	R ₁	L	Fiyat
955.102.11	19,05	9,5	14	19,05	4,76	2,4	57,2	36,00 €
955.103.11	38,1	17	18	20,7	6,00	1,8	55,5	44,00 €

*Fiyatlarımıza KDV Dahil Değildir.

*Diğer ölçüler için lütfen iletişime geçin.



JİLETLİ TEMİZLEME TOPU

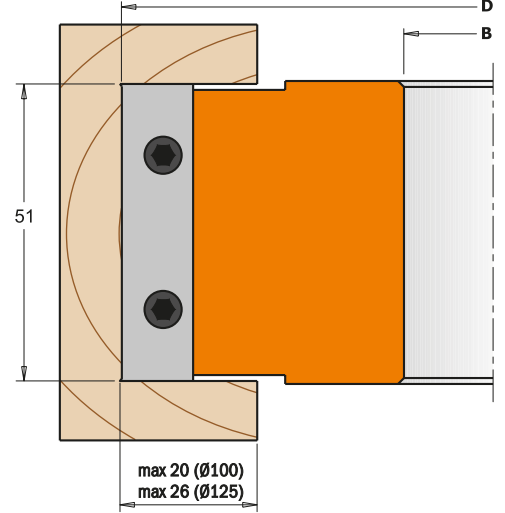

Order No.	D	I	B	Z+V	RPM	Jilet Order No.	Jilet	Fiyat
694.100.30	100	51	30	2+4	7500 - 12500	790.500.00 + 790.140.00	50x12x1.5 + 14x14x2	171,00 €
694.125.50	125	51	50	2+4	6100 - 10000	790.500.00 + 790.140.00	50x12x1.5 + 14x14x2	182,00 €

JİLETLİ TEMİZLEME TOPU

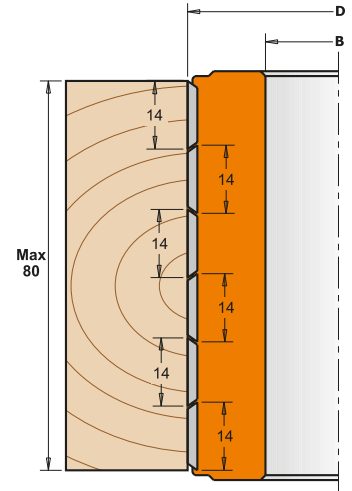
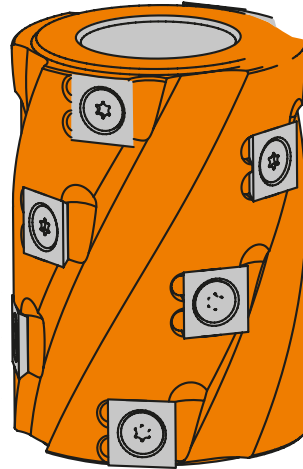

Order No.	D	I	B	Z	RPM	Jilet Order No.	Jilet	Fiyat
694.019.30	62	80	30	12	8000 - 12000	790.140.00	14x14x2	215,00 €

*Fiyatlarımıza KDV Dahil Değildir.

*Diğer ölçüler için lütfen iletişime geçin.



45 DERECE JİLETLİ FREZE TOPU

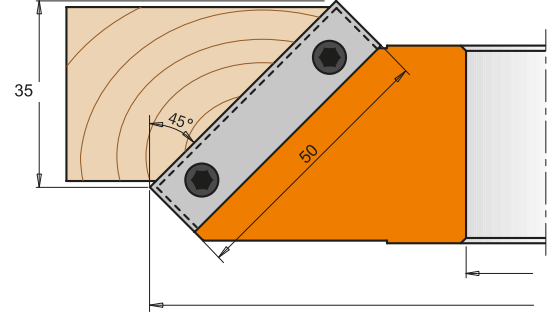

Order No.	D	B	Z	RPM	Jilet Order No.	Jilet	Fiyat
694.002.30	150	30	2	5100 - 8800	790.500.00	50x12x1.5	209,00 €

AYARLANABİLİR AÇILI JİLETLİ FREZE TOPU

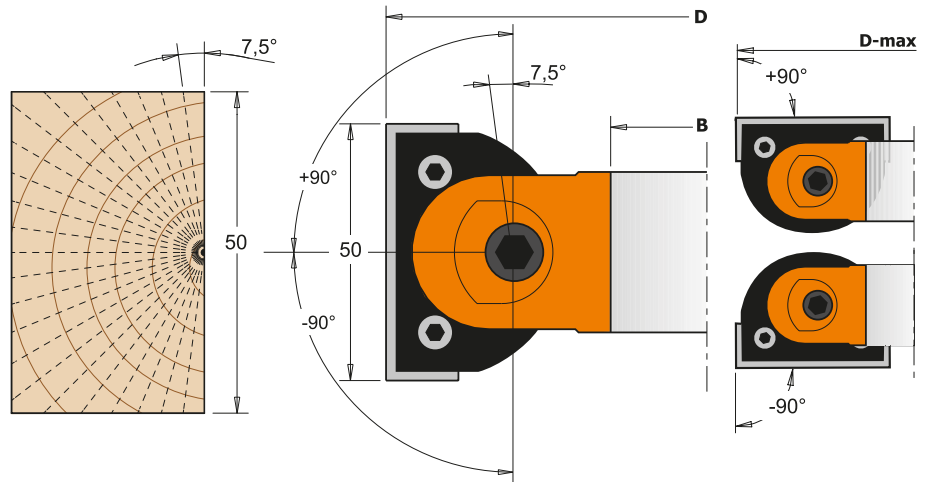

Order No.	D	I	B	Z	D_Max 45°	RPM	Jilet Order No.	Jilet	Fiyat
694.017.30	160	50	30	2	183	4800 - 6000	790.500.00	50x12x1.5	561,00 €

*Fiyatlarımıza KDV Dahil Değildir.

*Diğer ölçüler için lütfen iletişime geçin.



JİLETLİ KANAL FREZE TOPU

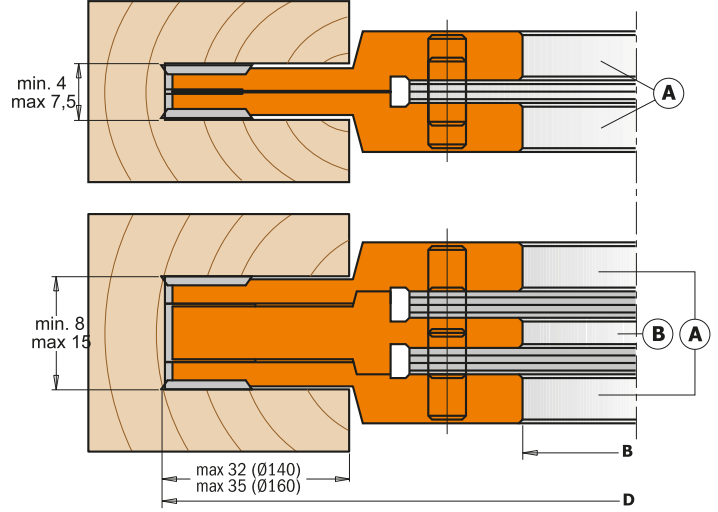

Order No.	D	I	B	Z+V	RPM	Jilet Order No.	Fiyat
694.001.30	140	4 - 15	30	4+4	5500 - 9500	790.181.00 + 790.140.10 + 790.076.00 18x18x2 + 14x14x1.2 + 7.6x12x1.5	229,00 €

JİLETLİ KANAL FREZE TOPU

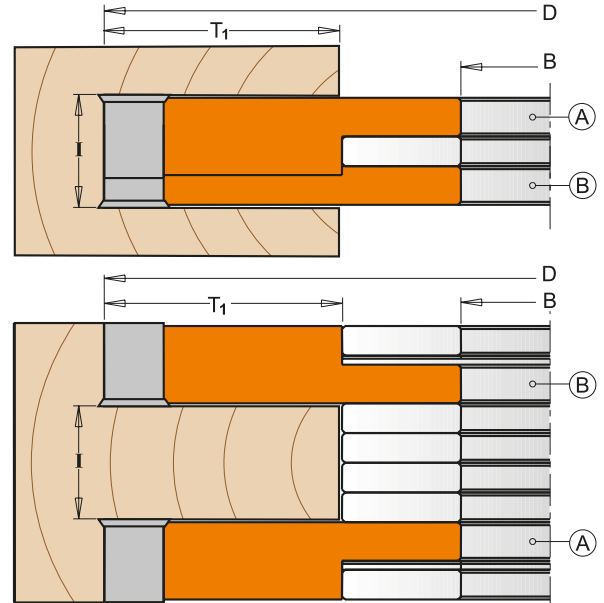
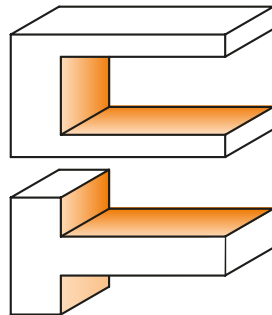

Order No.	D	I	T ₁	B	Z+V	RPM	Jilet Order No.	Jilet	Fiyat
694.021.30	150	14-27	44	30	4+4	5000 - 8000	790.136.00	13.6x13.6x2	242,00 €

*Fiyatlarımıza KDV Dahil Değildir.

*Diğer ölçüler için lütfen iletişime geçin.



JİLETLER

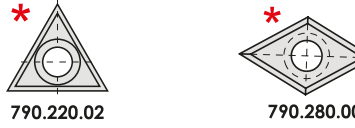
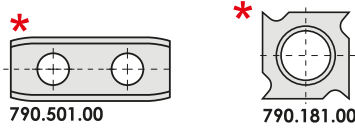
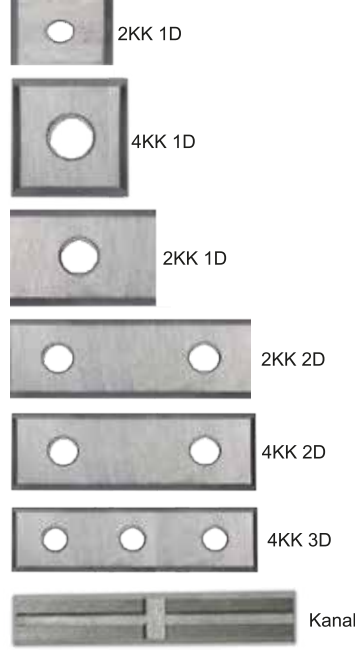
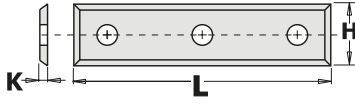

TIGRA		CMT		Keskin Kenar	Delik	Ölçüler L x H x K	Fiyat
Order No	Sınıf	Order No					
T-012001	T04F	790.075.00	2 KK	1 D	7,5x12x1,5	2,00 €	
T-012015	T04F	790.096.00	2 KK	1 D	9,6x12x1,5	2,40 €	
T-012002	T04F	790.120.00	4 KK	1 D	12x12x1,5	2,30 €	
T-013295	T08F	790.140.10	4 KK	1 D	14x14x1,2	2,60 €	
T-013260	T04F	790.140.00	4 KK	1 D	14x14x2,0	2,30 €	
T-012003	T04F	*	2 KK	1 D	15x12x1,5	2,40 €	
T-012004	T04F	790.200.00	2 KK	1 D	20x12x1,5	3,00 €	
T-012011	T04F	790.250.00	2 KK	2 D	25x12x1,5	3,70 €	
T-012005	T04F	790.300.00	2 KK	2 D	30x12x1,5	3,70 €	
T-013828	T03SMG	790.300.03	2 KK	2 D	30x12x1,5	4,70 €	
T-012014	T04F	790.400.00	2 KK	2 D	40x12x1,5	4,40 €	
T-012006	T04F	790.500.00	2 KK	2 D	50x12x1,5	4,60 €	
T-013834	T03SMG	790.501.00	2 KK	2 D	50x12 x1,5	5,70 €	
T-012007	T04F	790.600.00	2 KK	2 D	60x12x1,5	5,90 €	
T-013293	T04F	*790.181.00	4 KK	1 D	18x18x2,0	8,00 €	
T-013271	T08F	*790.220.02	3 KK	1 D	22x19x2,0	9,90 €	
T-013950	T03SMG	790.295.09	4 KK	2 D	29,5x9,0x1,5	5,70 €	
T-013517	T04F	790.495.09	4 KK	2 D	49,5x9,0x1,5	6,90 €	
T-013956	T03SMG	*	4 KK	2 D	49,5x9,0x1,5	7,70 €	
T-013507	T04F	790.295.12	4 KK	2 D	29,5x12x1,5	5,10 €	
T-013952	T03SMG	*	4 KK	2 D	29,5x12x1,5	6,10 €	
T-013957	T03SMG	790.495.12	4 KK	2 D	49,5x12x1,5	7,70 €	
T-013327	T04F	*	4 KK	3 D	50x12x1,7	7,70 €	
T-013866	T03SMG	*	4 KK	3 D	50x12x1,7	9,10 €	
T-013403	T04F	790.200.01	Kanal	*	20x4,1x1,1	4,30 €	
T-013394	T04F	*	Kanal	*	20x5,5x1,1	4,50 €	
T-013402	T04F	*	Kanal	*	25x5,5x1,1	4,70 €	
T-013397	T04F	790.300.01	Kanal	*	30x5,5x1,1	4,80 €	
T-013401	T04F	790.500.01	Kanal	*	50x5,5x1,1	7,30 €	
T-013020	T08F	790.820.00	Kanal	*	82x5.5x1x1	3,20 €	
CMT	K1920	790.500.09	4 KK	3 D	50x9,0x1,5	11,30 €	
CMT	K1920	*790.280.00	4 KK	1 D	28x14x 2,0	8,80 €	
CMT	K1920	790.360.01	4 KK	2 D	36x12x1,5	11,70 €	
CMT	K1920	790.483.12	4 KK	2 D	48.3x12x1.5	15,40 €	
CMT	K1920	*790.501.00	2 KK	2 D	48.3x12x1.6	9,50 €	

HSS PLANYALAR



Order No. LH	Ölçü	HSS Sınıfı	Fiyat
792.301.30	300x30x3	%6	9,90 €
792.311.35	310x35x3	%6	10,30 €
792.401.35	400x35x3	%6	13,50 €
792.501.35	500x35x3	%6	16,50 €
792.601.35	600x35x3	%6	19,80 €
792.998.35	1050x35x3	%6	34,70 €

Order No. LH	Ölçü	HSS Sınıfı	Fiyat
792.250.30	250x30x3	%18	13,90 €
792.300.30	300x30x3	%18	16,50 €
792.400.30	400x30x3	%18	22,00 €
792.500.30	500x30x3	%18	27,50 €
792.997.30	1050x30x3	%18	57,80 €

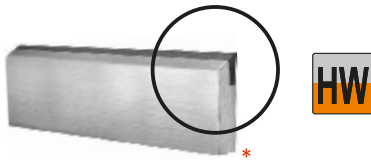

Order No. LH	Ölçü	HSS Sınıfı	Fiyat
*792.999.30	1050x30x3	HW Elmas	180,00 €

*Fiyatlarımıza KDV Dahil Değildir.

*Diğer ölçüler için lütfen iletişime geçin.



Neden Poliüretan Toz Emme Hortumu!

Tüm talaş emme sistemlerinde kullanılan ve sürtünmeden dolayı makinelerinizin elektriksel ekipmanlarına zarar verebilecek, yangın riskini arttıran elektriği, topraklamaya yardımcı olan bakır kaplı spiral tellerden imal endüstriyel toz emme hortumlarını da, tüm ölçülerde sizlere sunmaktayız.



PU 60	HAFİF HİZMET AMAÇLI
TEL CİNSİ:	SG-2 ANTİSTATİK ÇELİK TEL
RENK :	ŞEFFAF
ET KALINLIĞI :	0,40 - 0,45 mm
TEL ARALIĞI :	15 mm - 32 mm

PU 70	ORTA HİZMET AMAÇLI
TEL CİNSİ:	BAKIR ANTİSTATİK ÇELİK TEL
RENK :	ŞEFFAF
ET KALINLIĞI :	0,40 - 0,45 mm
TEL ARALIĞI :	15 mm - 32 mm

PU 100	AĞIR HİZMET AMAÇLI
TEL CİNSİ:	BAKIR KAPLI ÇELİK TEL
RENK :	ŞEFFAF
ET KALINLIĞI :	0,55 - 0,60 mm
TEL ARALIĞI :	15 mm - 32 mm

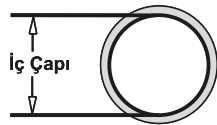

Ölçü	Fiyat		
	mt/€	mt/€	mt/€
Ø 60 mm	6,50 €	8,00 €	10,00 €
Ø 70 mm	6,50 €	9,00 €	12,00 €
Ø 80 mm	7,00 €	10,50 €	12,50 €
Ø 102 mm	8,00 €	12,00 €	15,50 €
Ø 110 mm	8,50 €	12,50 €	16,00 €
Ø 120 mm	9,00 €	13,50 €	17,00 €
Ø 130 mm	10,50 €	15,50 €	20,00 €
Ø 140 mm	11,50 €	17,50 €	21,50 €
Ø 152 mm	12,00 €	18,50 €	23,00 €
Ø 160 mm	13,00 €	20,00 €	25,50 €
Ø 180 mm	15,00 €	22,00 €	28,50 €
Ø 203 mm	17,00 €	25,00 €	31,50 €
Ø 225 mm	20,00 €	30,00 €	38,00 €
Ø 250 mm	23,00 €	33,00 €	43,00 €
Ø 275 mm	25,00 €	47,50 €	47,00 €
Ø 305 mm	29,00 €	57,00 €	71,00 €

*PU 60 ve PU 70 Paketi 10 Mt dir. Minimum Sipariş Miktarı 10 Mt dir.
*PU 100 İsteğe Göre Mt. Olarak Sipariş Verilebilir.

*Fiyatlarımıza KDV Dahil Değildir.

*Hortumla ilgili diğer ölçüler için lütfen iletişime geçin.

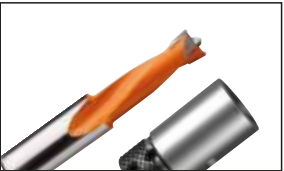

**ORMEND MAKİNA
SAN. TİC. LTD. ŞTİ.**

**CMT ORANGE TOOLS ÜRÜNLERİNİN
BAYİLERE DAĞITIMI VE TÜRKİYE GENELİNDE
TEMSİLCİLİK KONUSUNDA
TEK YETKİLİDİR.**



ormendmakina



ormendmakina



ormendmakina



ormendmakina



A large grid of small squares, typical of graph paper, covering the majority of the page.



ORMEND
MAKİNA SAN. TİC. LTD. ŞTİ.

Şerifali Mah. Türker Cad. No: 32/A,
34775, Ümraniye / İstanbul / TÜRKİYE
T: +90 216 527 01 12 - 13
F: +90 216 527 01 14
info@ormendmakina.com
www.ormendmakina.com



ormendmakina



ormendmakina



ormendmakina



ormendmakina